



GSM/UMTS ANTENNA

Antenna GSM/UMTS

Magnetic U50, 5 dBi, SMA(m),
.195, 3 m

AO-AUMTS-MG5S

SECTRON company offers a wide portfolio of GSM/UMTS antennas with various versions differing in shape, level of gain and manner of attachment. SECTRON guarantees a compatible connection between an antenna and all antenna adaptors produced by SECTRON.



BENEFITS

- Low VSWR
- High Gain
- Easy installation

Technology	GSM/UMTS
Frequency bands	900/1800/1900/2100 MHz
Bandwidth	-
Gain	5 dBi
VSWR	<2.0:1
Impedance	50 Ohm
Directivity	Omnidirectional
Beam angle	H 360° V 30°
Polarization	Linear
Maximum input power	10 W
Power voltage	-
Dimensions	350 x \varnothing 81 mm
Weight	315.55 g
Operating temperature	-30 to +80 °C
Execution	External
Method of attachment	Magnetic
Cable type	.195
The cable length	3 m
Connector type	SMA(m)

DRAWING

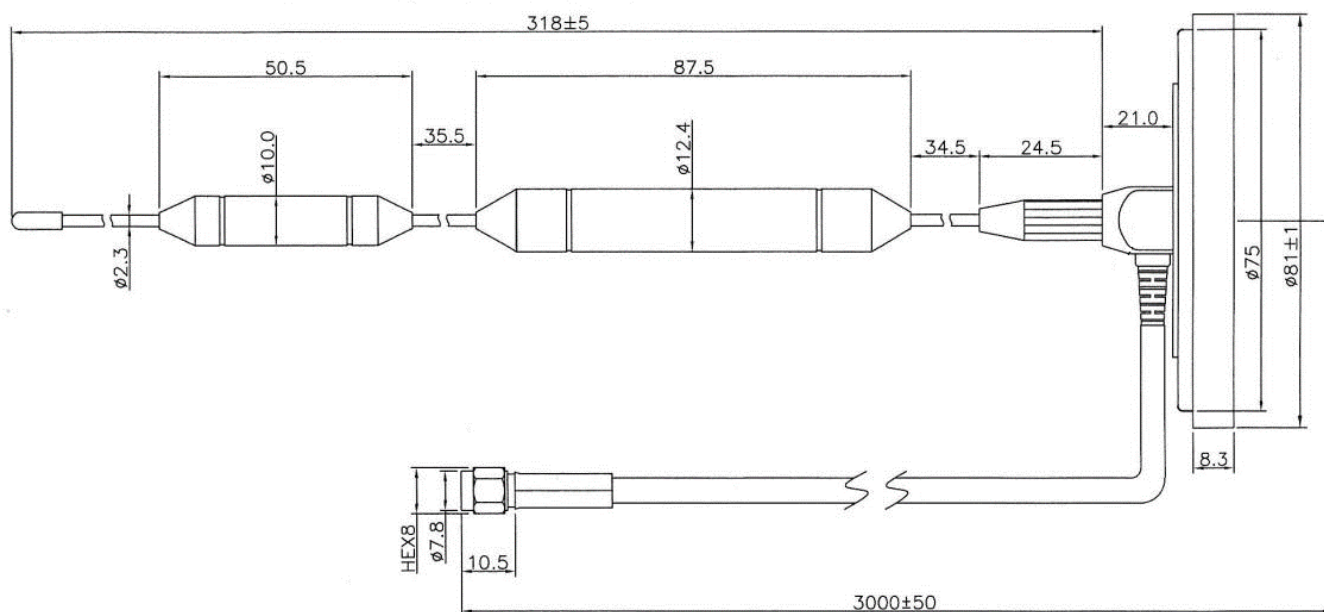

900 MHz

Far-field amplitude E-plane

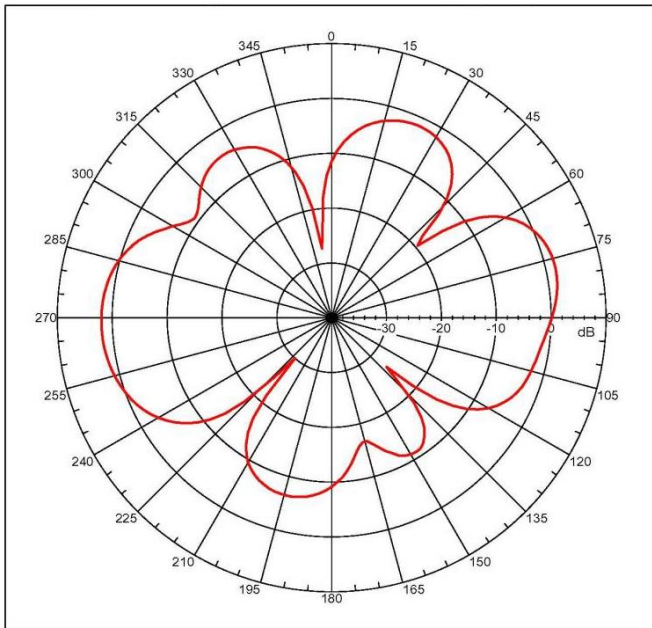

Far-field amplitude H-plane

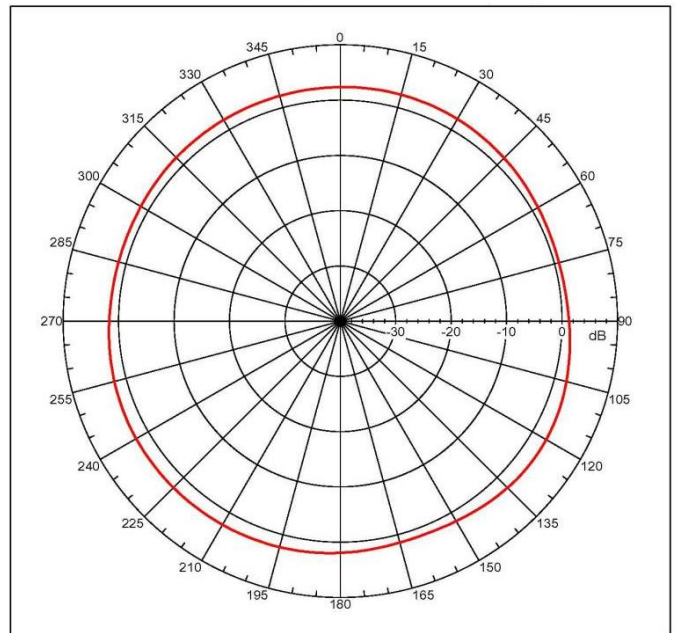

1 800 MHz

Far-field amplitude E-plane

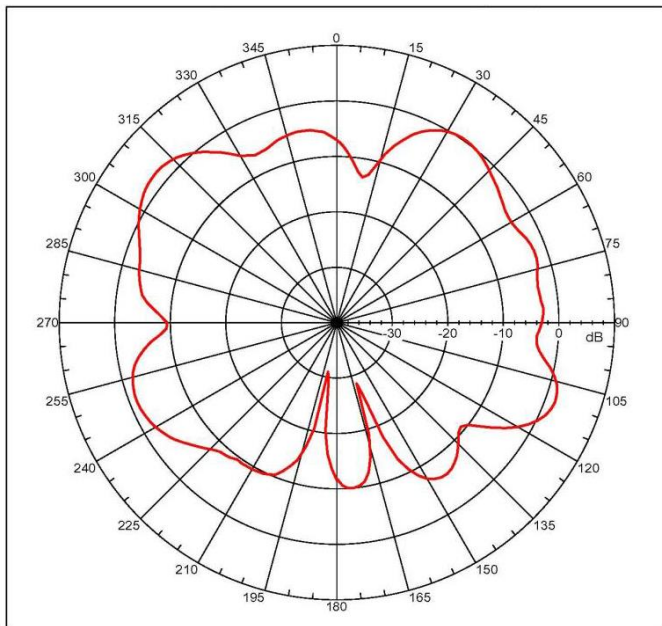

Far-field amplitude H-plane

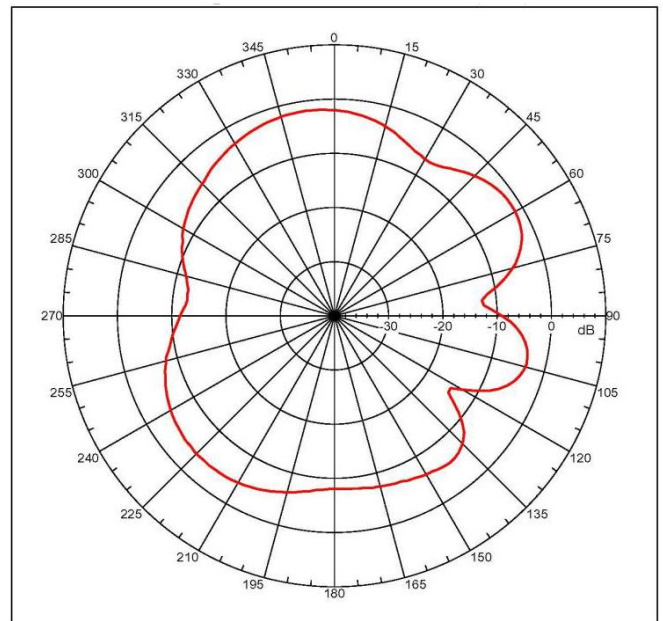

1 900 MHz

Far-field amplitude E-plane

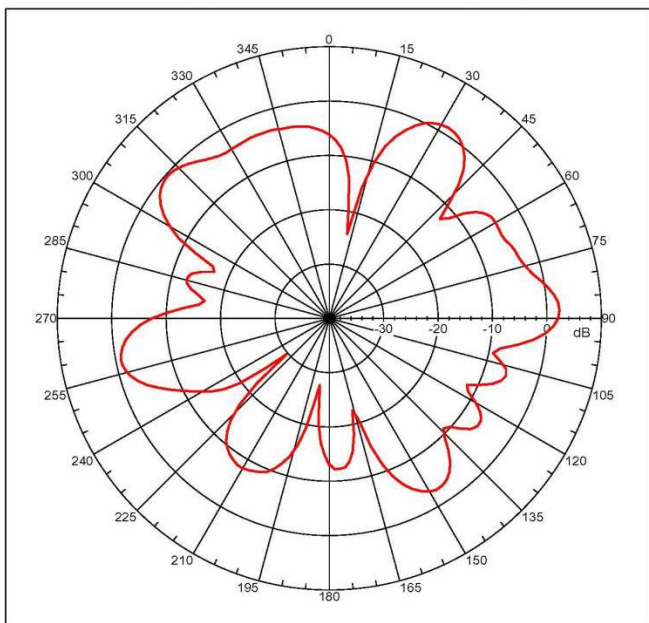

Far-field amplitude H-plane

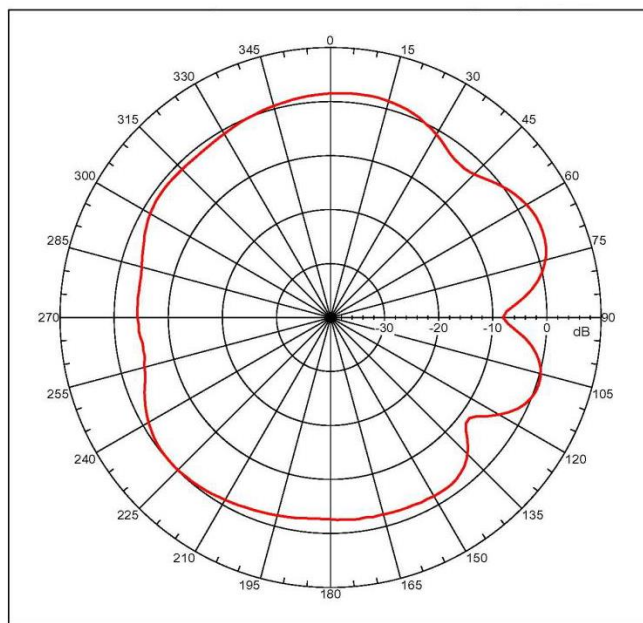

2 100 MHz

Far-field amplitude E-plane

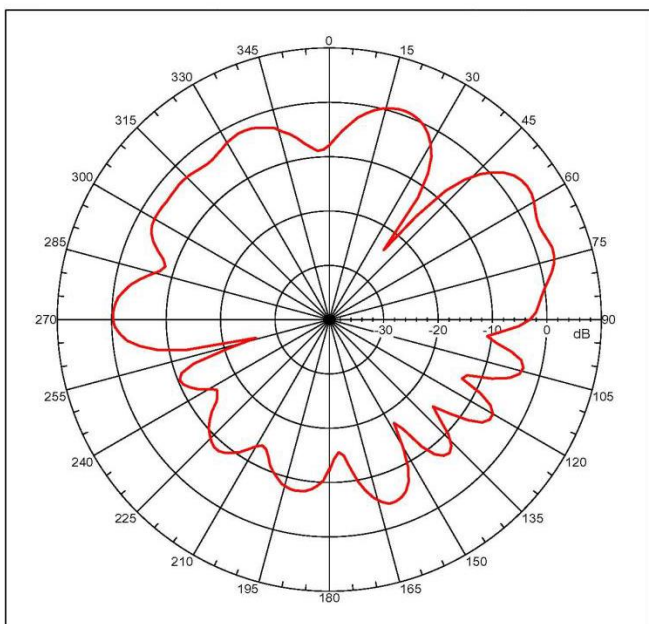

Far-field amplitude H-plane

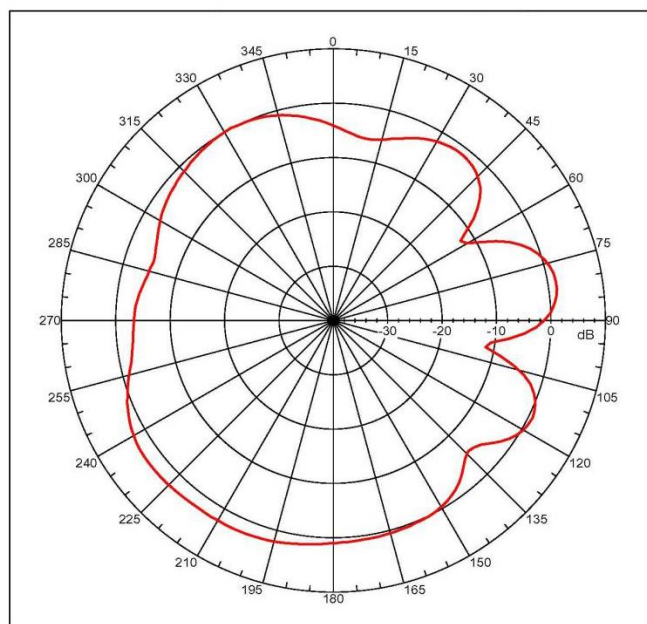

CONTACTS

SECTRON s.r.o. Josefa Šavla 1271/12
709 00 Ostrava 9, Czech Republic

WWW.SECTRON.CZ
Tel.: +420 556 621 021

VARIANT	PART NUMBER

CONTACTS

SECTRON s.r.o. Josefa Šavla 1271/12
709 00 Ostrava 9, Czech Republic

WWW.SECTRON.CZ
Tel.: +420 556 621 021