



# GSM/UMTS ANTENNA

Antenna GSM/UMTS Magnet Mount 20,  
2 dBi, SMA(m), RG174/3m

AO-AUMTS-M2S

SECTRON company offers wide portfolio GSM/UMTS antennas with various versions differing in shape, level of gain or attachment manner. SECTRON guarantees compatible connection between antenna and all antenna adaptors produced by SECTRON.



## BENEFITS

- Low VSWR
- Easy installation
- Omnidirectional - suitable for moving devices

Technology	GSM/UMTS
Frequency bands	800/900/1800/1900/2100 MHz
Bandwidth	-
Gain	2 dBi
VSWR	<2.0: 1
Impedance	50 ohm
Directivity	Omnidirectional
Beam angle	H 360° V 30°
Polarization	Vertical
Maximum input power	10 W
Power voltage	-
Dimensions	101 x 34 mm
Weight	65 g
Operating temperature	-20 to +60 °C
Execution	External
Method of attachment	Magnet Mount
Cable type	RG174
The cable length	3 m
Connector type	SMA(m)

DRAWING

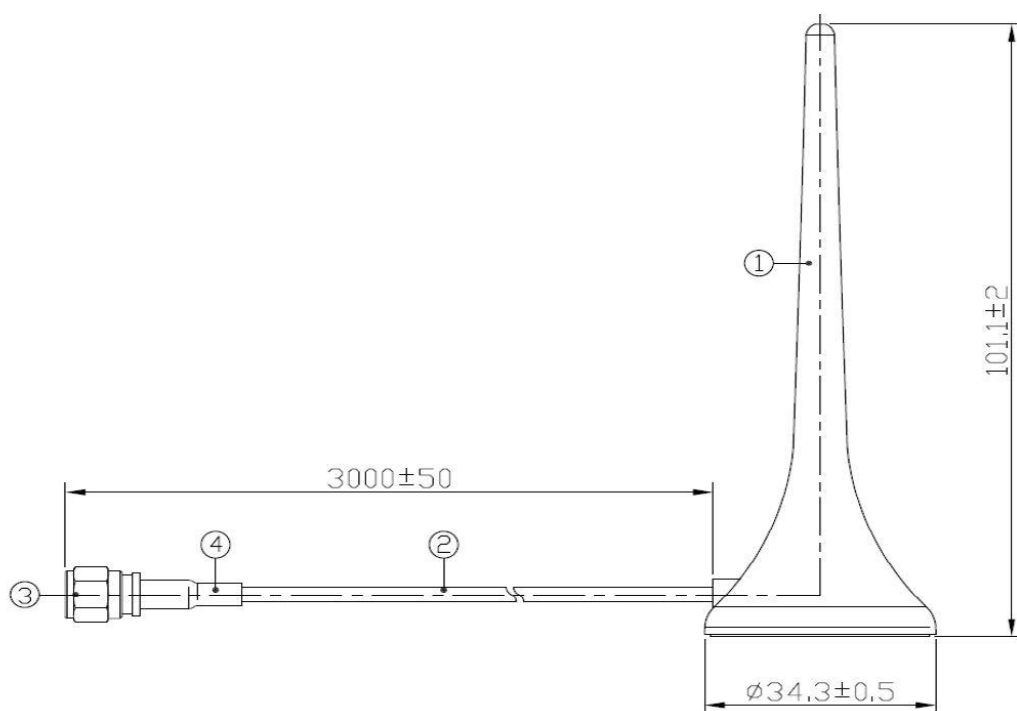

Units: mm

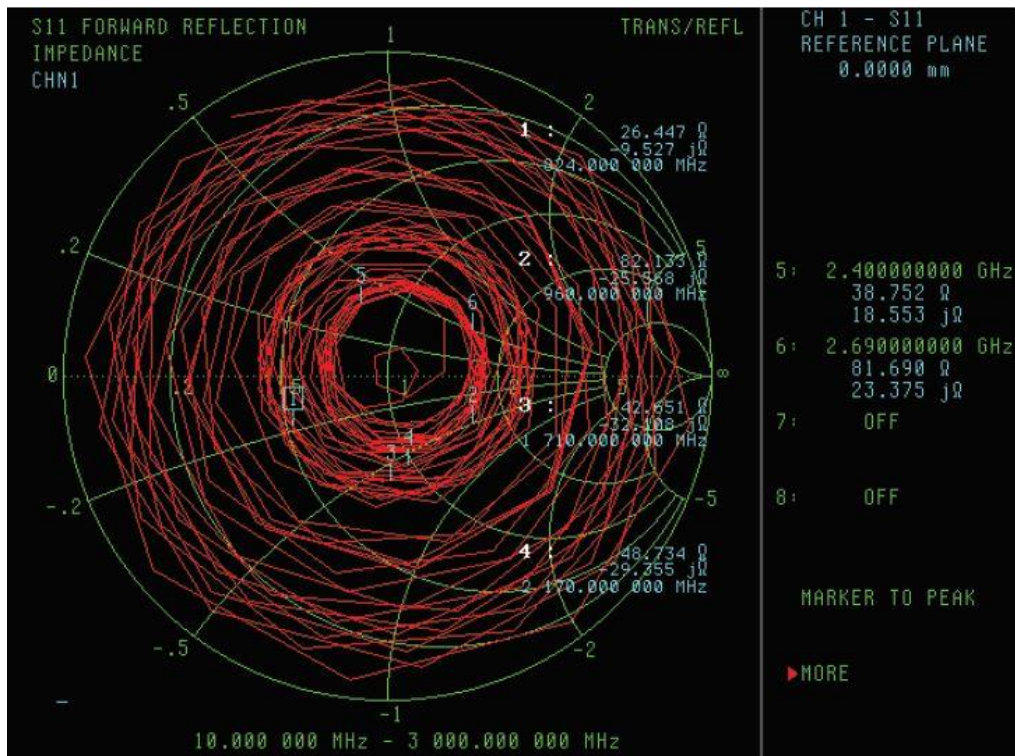
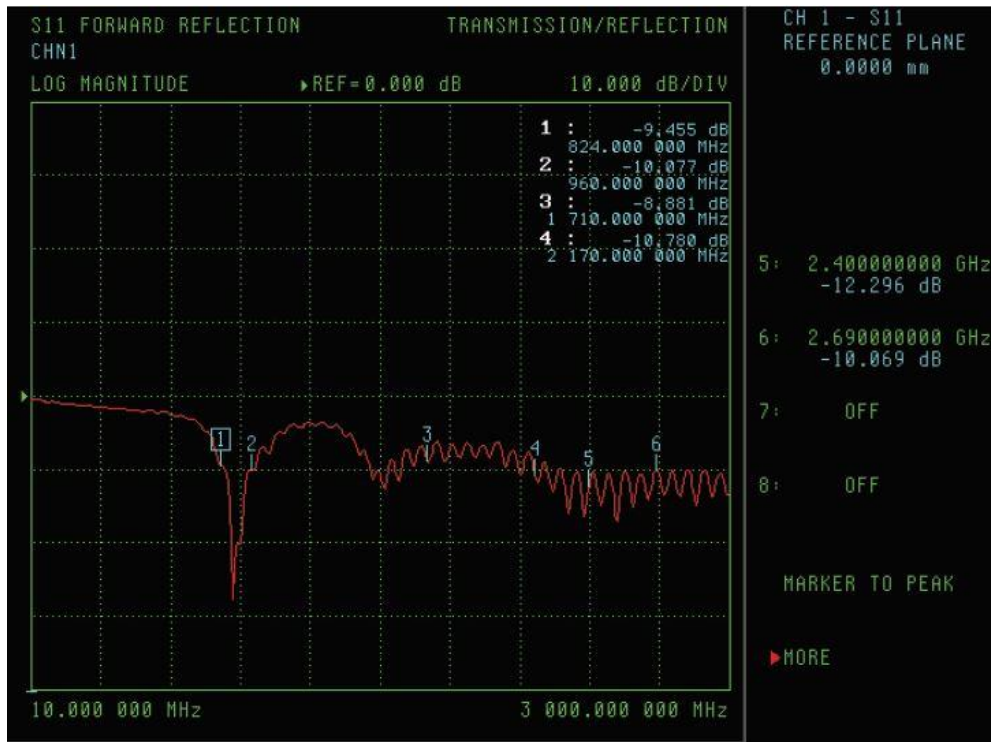

Far-field amplitude of 20120528W900-H01.nsi

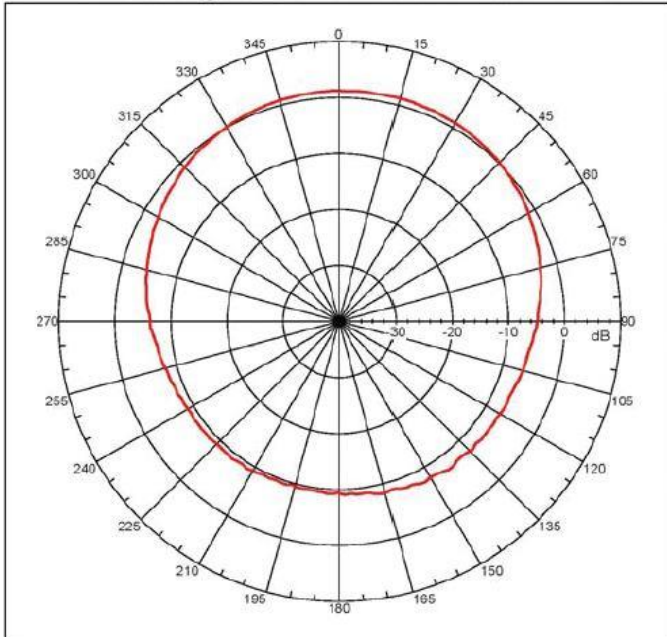

Far-field amplitude of 20120528W900-H01.nsi

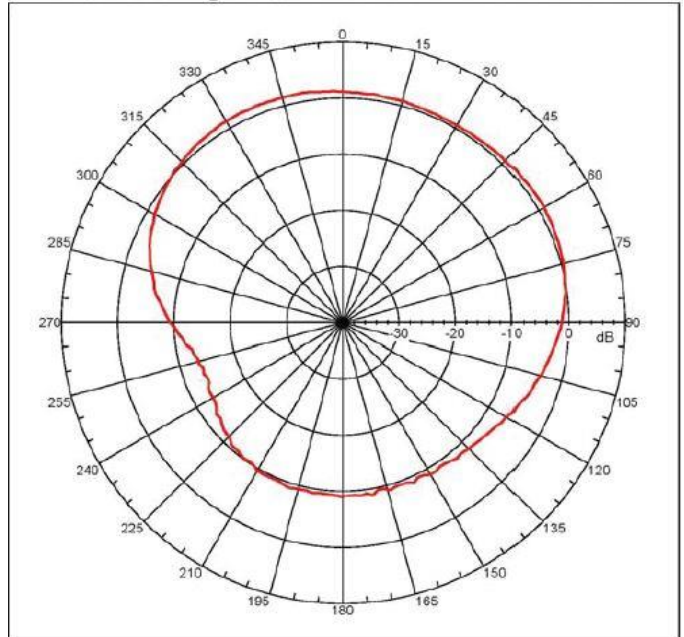

Far-field amplitude of 20120528W900-H01.nsi

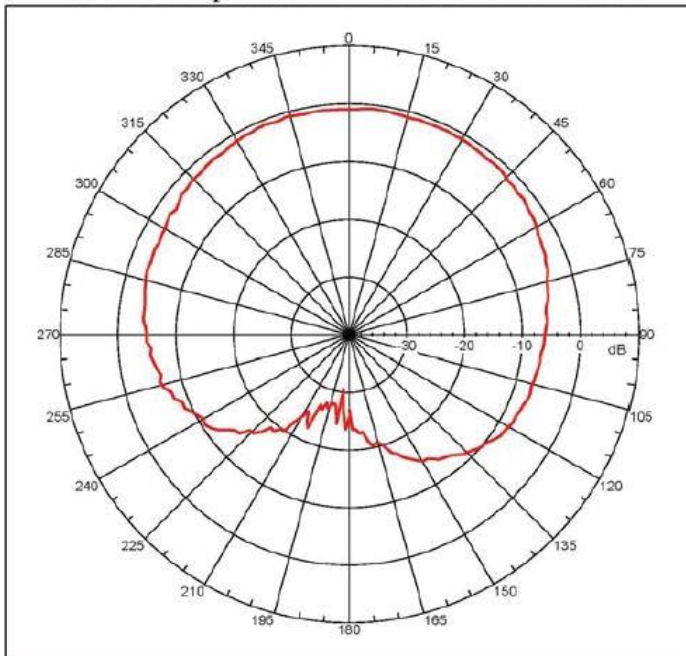

Far-field amplitude of 20120528W900-H01.nsi

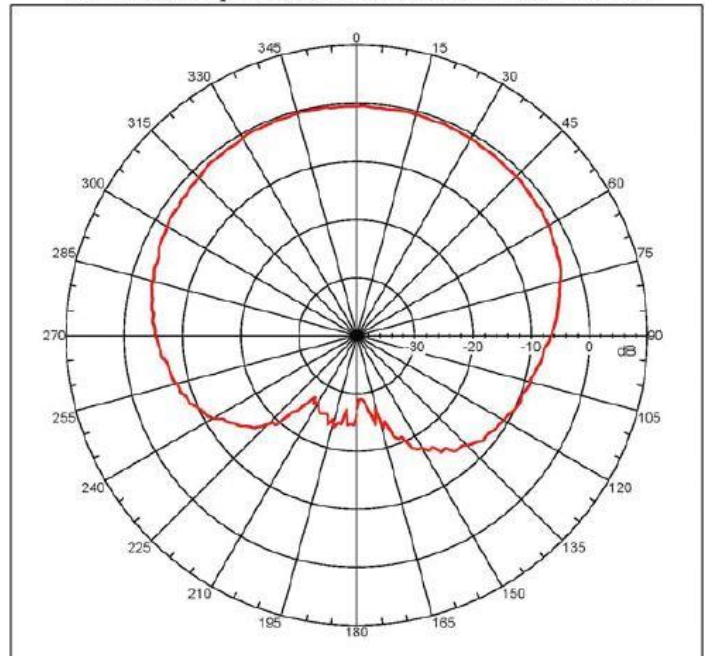

Different connector variants or cable lengths are available on request.

CONTACTS

---

SECTRON s.r.o. Josefa Šavla 1271/12  
709 00 Ostrava 9, Czech Republic

WWW.SECTRON.CZ  
Tel.: +420 556 621 020