



LTE ANTENNA

Antenna LTE MIMO Mount PUK,
RG174/3m, RG174/3m, SMA(m),
SMA(m)

AO-ALTE-39DS

SECTRON company offers a wide portfolio of LTE antennas with various versions differing in shape, level of gain and manner of attachment. SECTRON guarantees a compatible connection between an antenna and all antenna adaptors produced by SECTRON.



BENEFITS

- Anti-vandal design
- MIMO antenna

Technology	LTE
Frequency bands	700/800/900/1700/1800/1900/2100/2600/2700 MHz
Bandwidth	-
Gain	4 dBi
VSWR	<3.0: 1
Impedance	50 Ohm
Directivity	Omnidirectional
Beam angle	H 360° V 30°
Polarization	Linear
Maximum input power	10 W
Power voltage	-
Dimensions	80 x 25 mm
Weight	157.57 g
Operating temperature	-30 to +90 ° C
Execution	External
Method of attachment	Mounting
Cable type	2 x RG 174/U
The cable length	2 x 3 m
Connector type	2 x SMA(m)

DRAWING

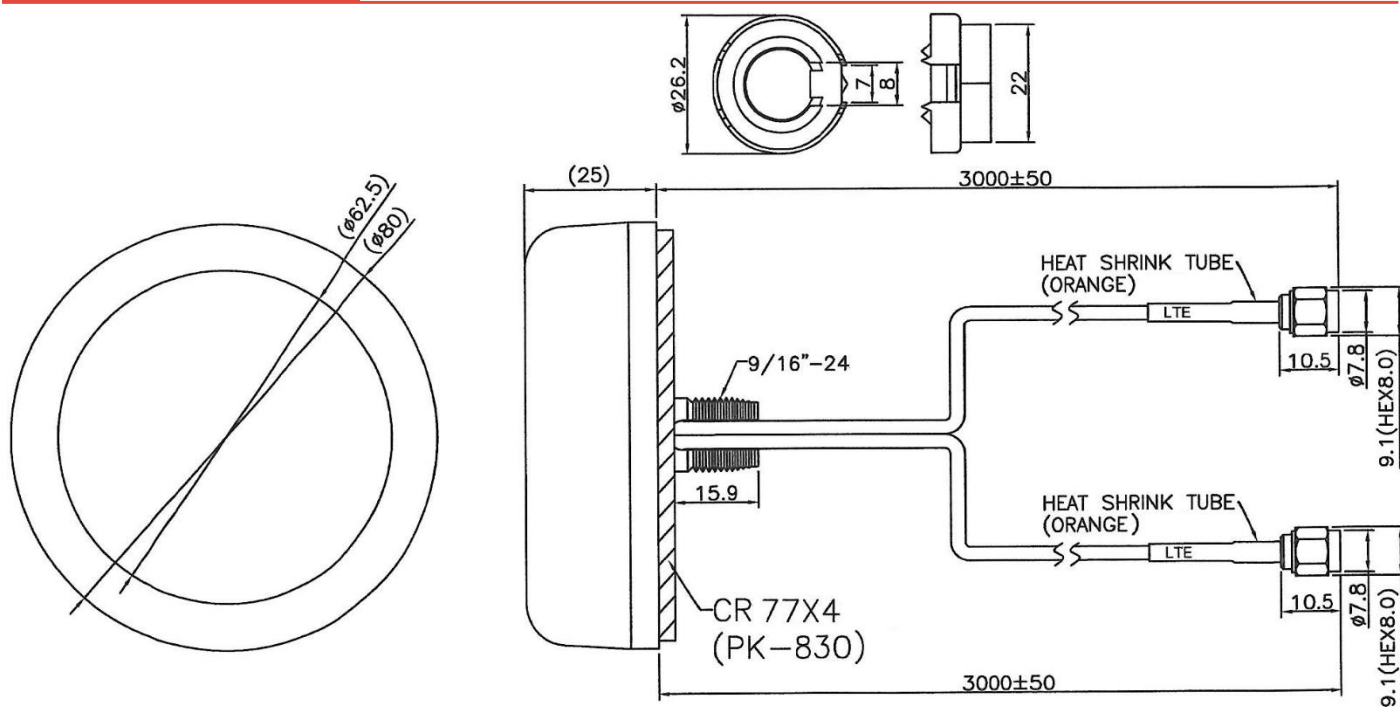

UNIT: mm

172 S11 Log Mag 10.00ds/ Ref 0.000ds

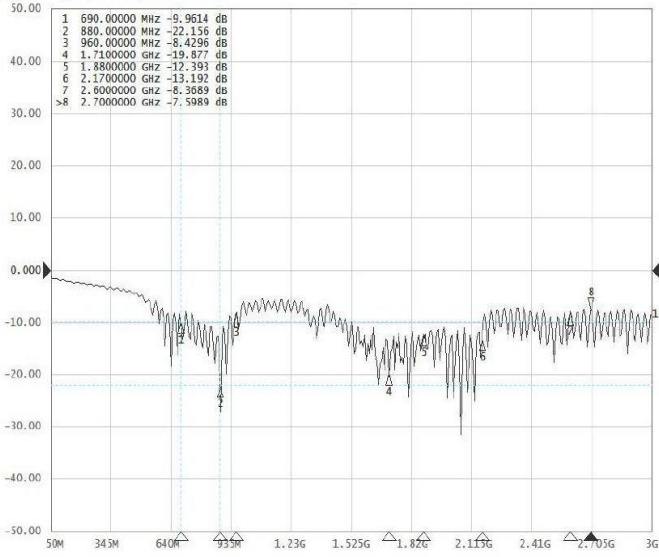

173 S11 SWR 1.000/ Ref 1.000

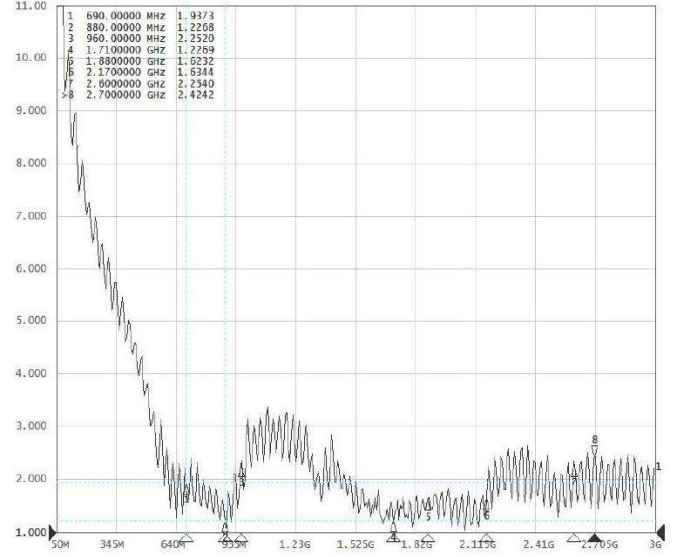

174 S11 Log Mag 10.00ds/ Ref 0.000ds

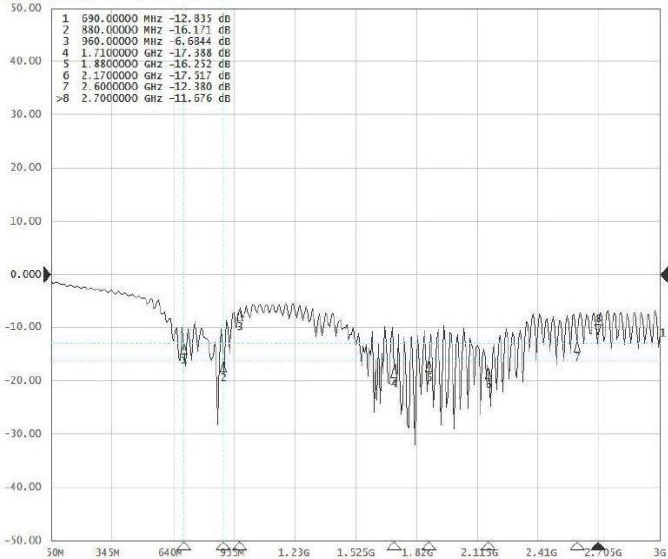

175 S11 SWR 1.000/ Ref 1.000

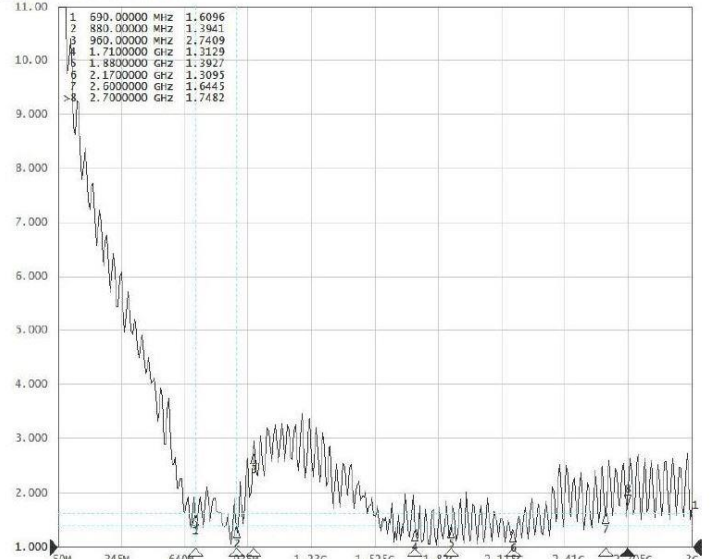

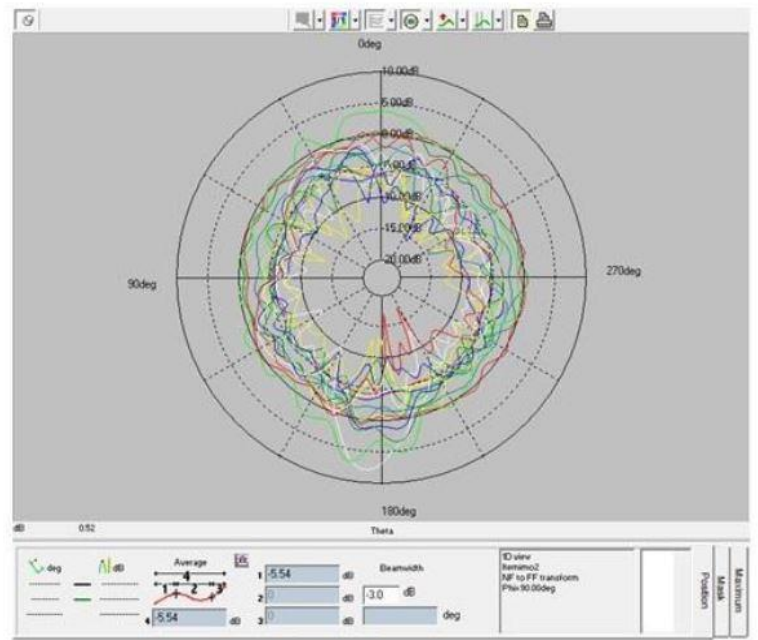
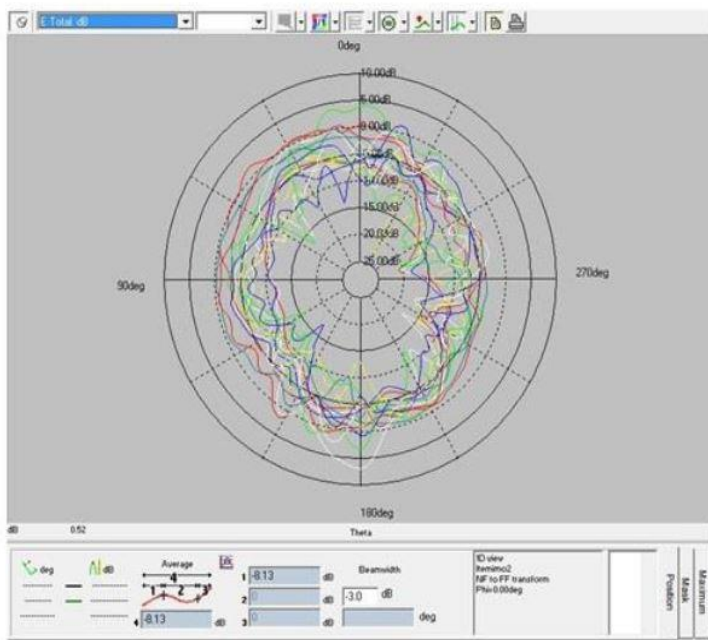

CONTACTS

SECTRON s.r.o. Josefa Šavla 1271/12
709 00 Ostrava 9, Czech Republic

WWW.SECTRON.CZ
Tel.: +420 556 621 021