



## LTE/WiFi ANTENNA

Antenna LTE/WiFi Screw Mount 046,  
SMA(m),SMA-RP(m), RG174/3m

AO-AKOM-G046SSRP3

SECTRON company offers a wide portfolio of LTE/WiFi antennas with various versions differing in shape, level of gain and manner of attachment. SECTRON guarantees a compatible connection between an antenna and all antenna adaptors produced by SECTRON.



### BENEFITS

- Low VSWR
- Anti-vandal design
- Optimized radiation pattern

## FEATURES

AO-AKOM-G046SSRP3

Technology	LTE/WiFi
Frequency bands	698 960;1710 2690/2400 2483.5;4900 5825 MHz
Bandwidth	-
Gain	2.5/3 dBi
VSWR	<2.0:1
Impedance	50 Ohm
Directivity	Omnidirectional
Beam angle	Attached graphs bellow
Polarization	Linear
Maximum input power	10 W
Power voltage	-
Dimensions	Ø 81.3 x 14.6 mm
Weight	142.89 g
Operating temperature	-40 to +85 °C
Execution	External
Method of attachment	Screw mount
Cable type	RG174/U
The cable length	2 x 3 m
Connector type	SMA(m)/SMA-RP
Certification	RoHS
IP code	IP67
Material	ABS

## DRAWING

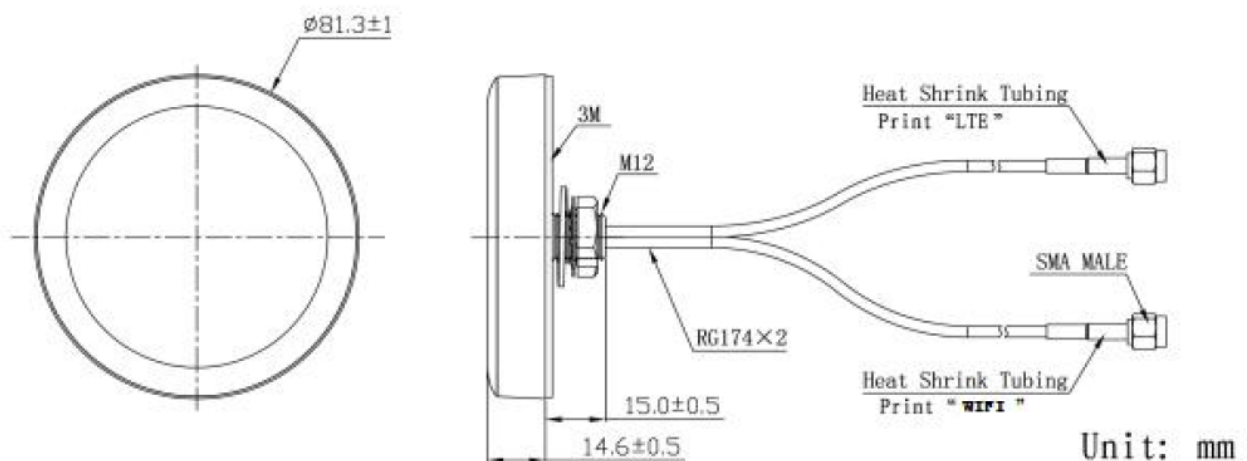

RADIATION PATTERN - 2D (LTE)

XY PLANE

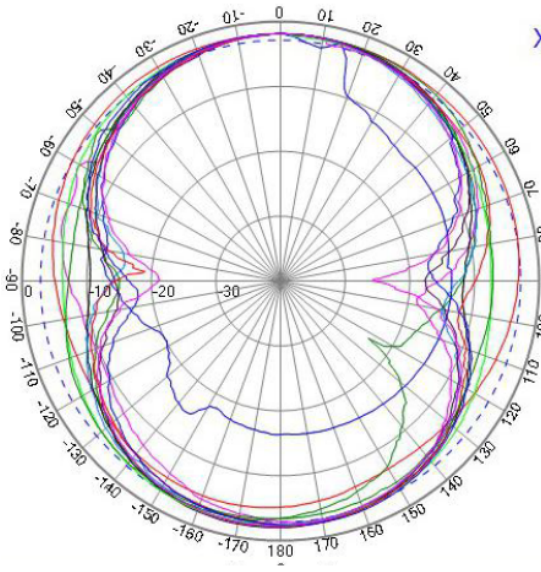

- Freq: 700
- Freq: 824
- Freq: 868
- Freq: 960
- Freq: 1710
- Freq: 1850
- Freq: 1990
- Freq: 2170
- Freq: 2300
- Freq: 2400
- Freq: 2500
- Freq: 2690

XZ PLANE

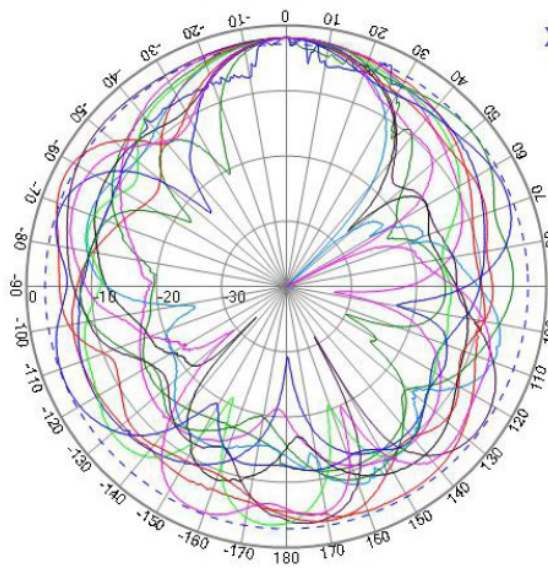

- Freq: 700
- Freq: 824
- Freq: 868
- Freq: 960
- Freq: 1710
- Freq: 1850
- Freq: 1990
- Freq: 2170
- Freq: 2300
- Freq: 2400
- Freq: 2500
- Freq: 2690

RADIATION PATTERN - 2D (WiFi)

XY PLANE

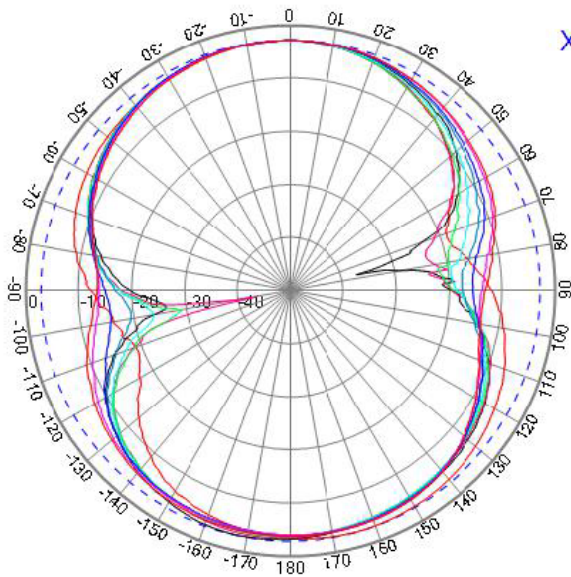

- Freq: 2400
- Freq: 2410
- Freq: 2420
- Freq: 2430
- Freq: 2440
- Freq: 2450
- Freq: 2460
- Freq: 2470
- Freq: 2483

XY PLANE

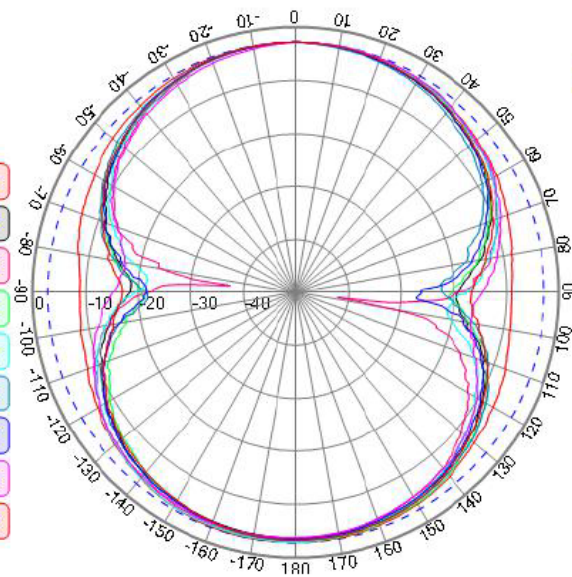

- Freq: 4900
- Freq: 5000
- Freq: 5100
- Freq: 5200
- Freq: 5300
- Freq: 5400
- Freq: 5500
- Freq: 5600
- Freq: 5800

XZ PLANE

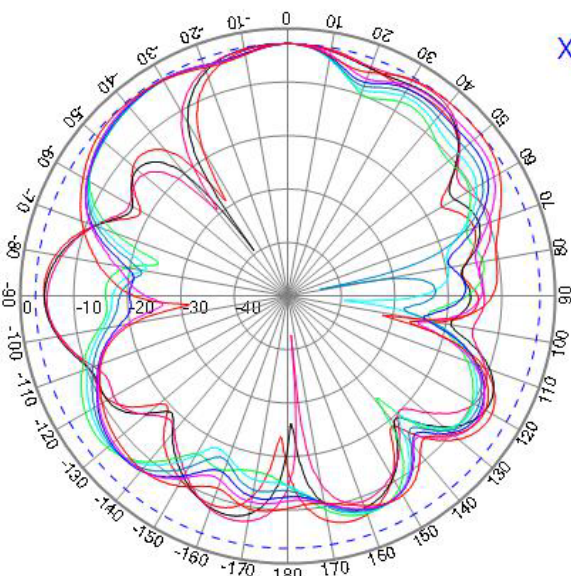

- Freq: 2400
- Freq: 2410
- Freq: 2420
- Freq: 2430
- Freq: 2440
- Freq: 2450
- Freq: 2460
- Freq: 2470
- Freq: 2483

XZ PLANE

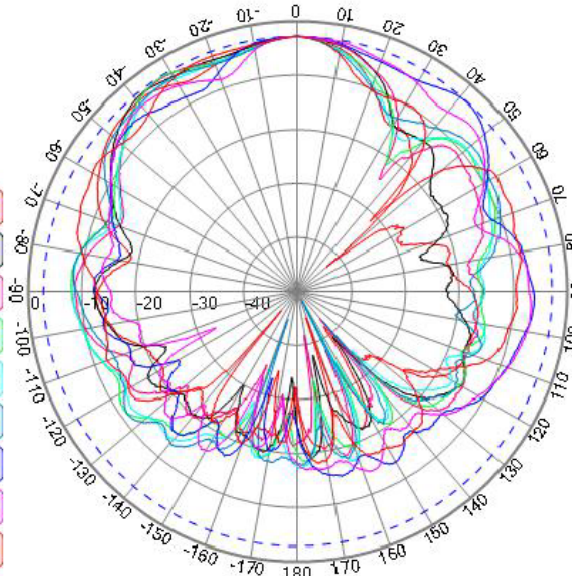

- Freq: 4900
- Freq: 5000
- Freq: 5100
- Freq: 5200
- Freq: 5300
- Freq: 5400
- Freq: 5500
- Freq: 5600
- Freq: 5800

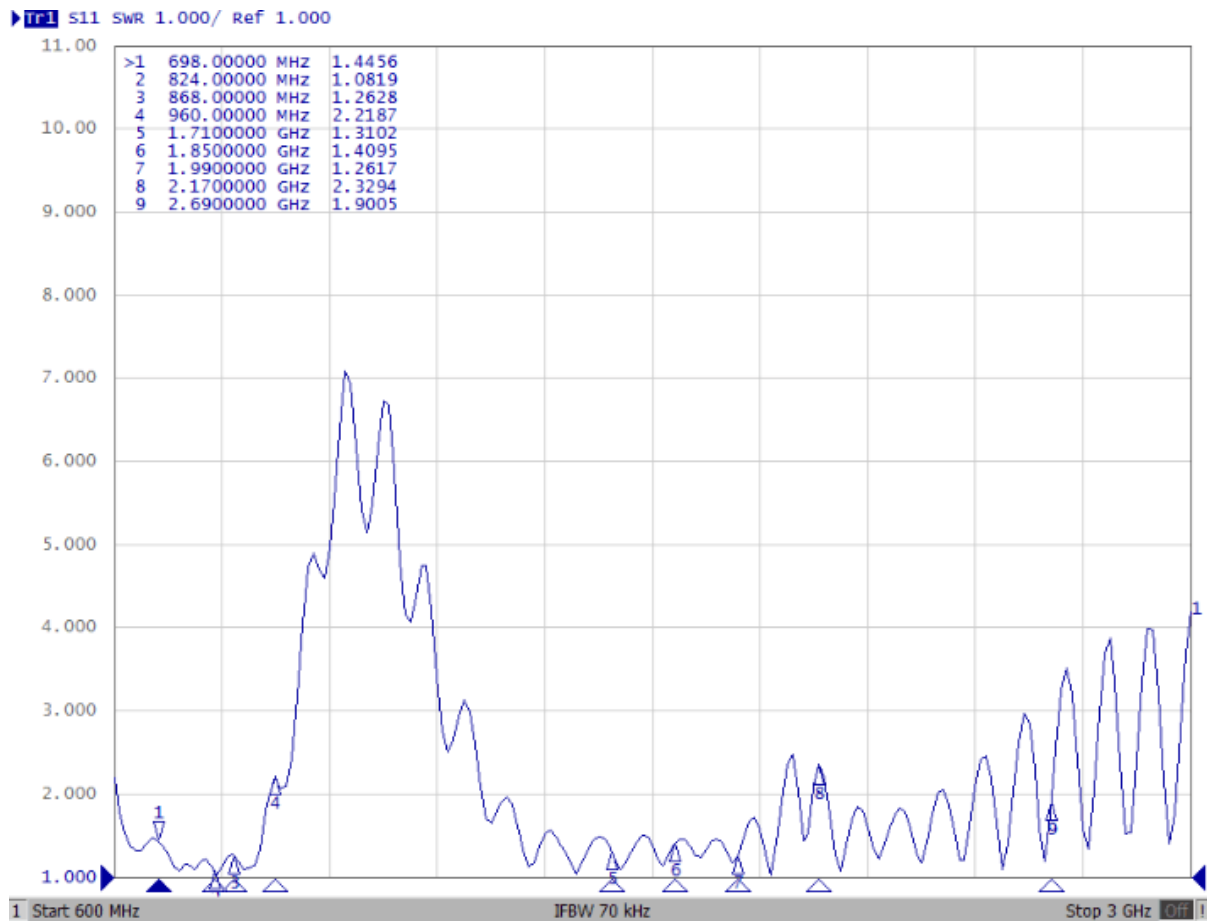
**VSWR – Voltage standing wave ratio [-]****VARIANTS**

Different connector variants or cable lengths are available on request.

**CONTACTS**

SECTRON s.r.o. Josefa Šavla 1271/12  
709 00 Ostrava 9, Czech Republic

WWW.SECTRON.CZ  
Tel.: +420 556 621 020