



LTE/GPS ANTENNA

Antenna LTE/GPS Screw Mount 046L,
2x SMA(m), 2x RG174/3m, IP67

AO-AKOM-G046LSS3

SECTRON company offers a wide portfolio of LTE/GPS antennas with various versions differing in shape, level of gain and manner of attachment. SECTRON guarantees a compatible connection between an antenna and all antenna adaptors produced by SECTRON.



BENEFITS

- Low VSWR
- Optimized radiation pattern
- Easy mounting
- IP67

Technology	LTE/GPS
Frequency bands	698 – 960/1710 – 2690 MHz; 1575.42 ± 1 MHz
Bandwidth	-
Gain	2.5 dBi / 2 dBi
LNA Gain	28 dB
VSWR	<2.0:1 / <1.5:1
Impedance	50 Ohm
Directivity	Omnidirectional / Directional
Beam angle	Attached graphs bellow
Polarization	Linear / R.H.C.P
Maximum input power	10 W
Power voltage	2.2-5 VDC
Dimensions	Ø 81.3 x 29.6 mm
Weight	154.22 g
Operating temperature	-40°C to +85 °C
Execution	External
Method of attachment	Screw mount
Cable type	RG174/U
The cable length	3 m
Connector type	SMA(m)/SMA(m)
Certification	RoHS
IP code	IP67 (exclude cable outlet)
	ABS

DRAWING

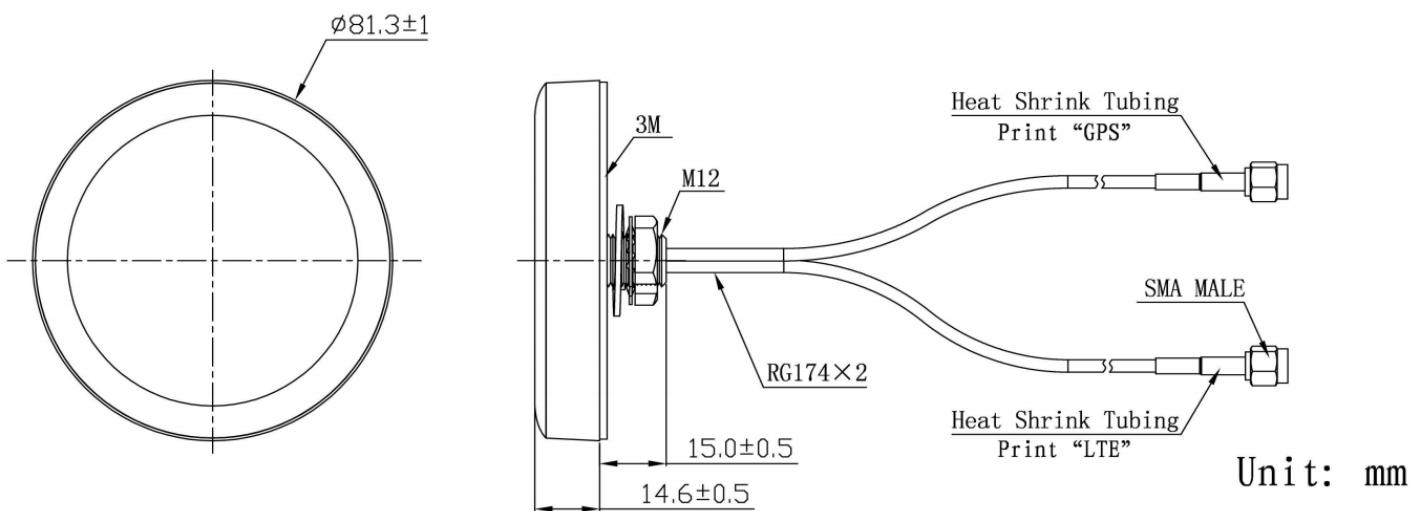

RADIATION PATTERN - GPS

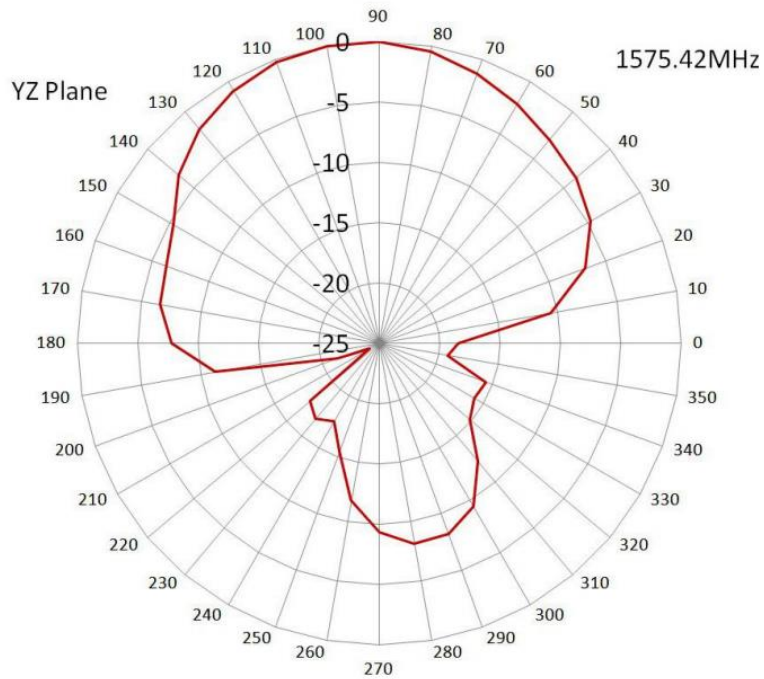
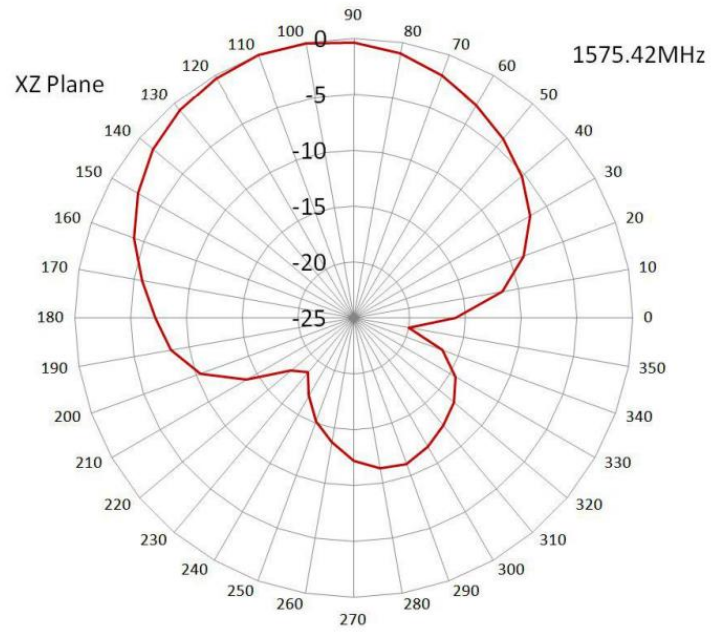
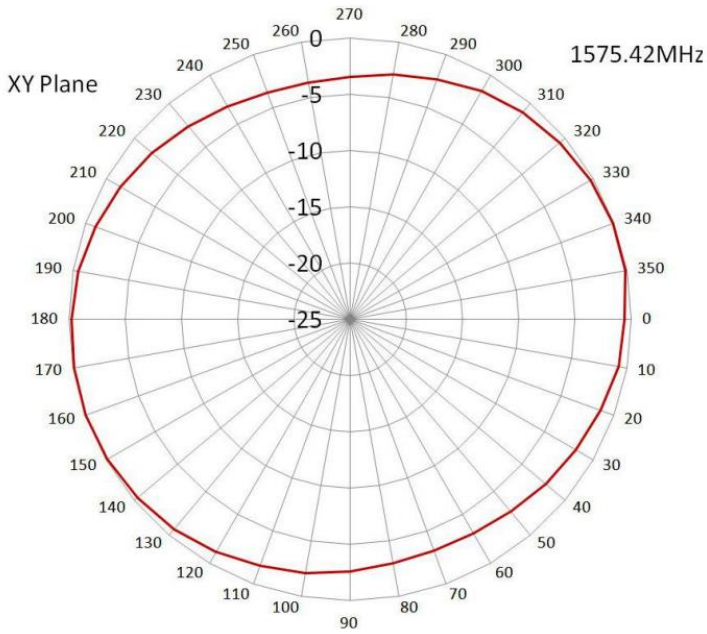

RADIATION PATTERN - LTE

XY PLANE

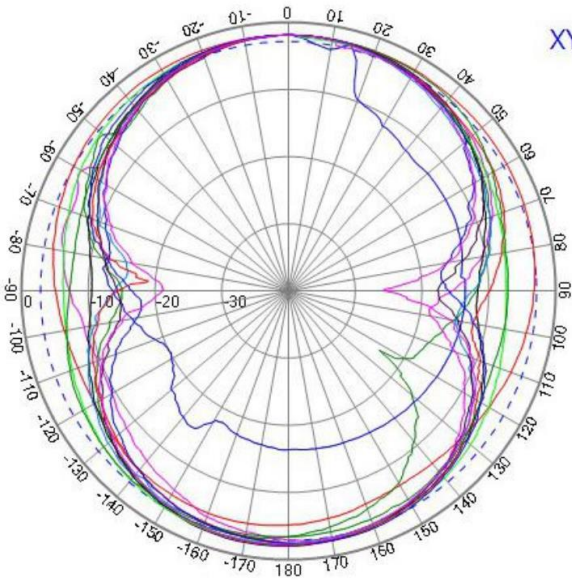

- Freq: 700
- Freq: 824
- Freq: 868
- Freq: 960
- Freq: 1710
- Freq: 1850
- Freq: 1990
- Freq: 2170
- Freq: 2300
- Freq: 2400
- Freq: 2500
- Freq: 2690

XZ PLANE

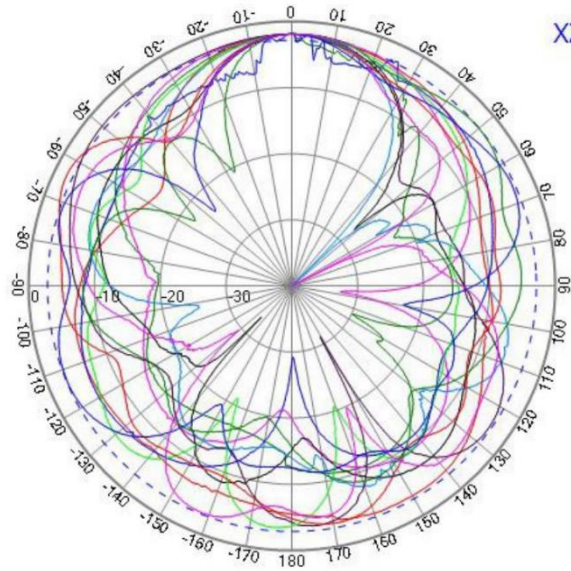

- Freq: 700
- Freq: 824
- Freq: 868
- Freq: 960
- Freq: 1710
- Freq: 1850
- Freq: 1990
- Freq: 2170
- Freq: 2300
- Freq: 2400
- Freq: 2500
- Freq: 2690

YZ PLANE

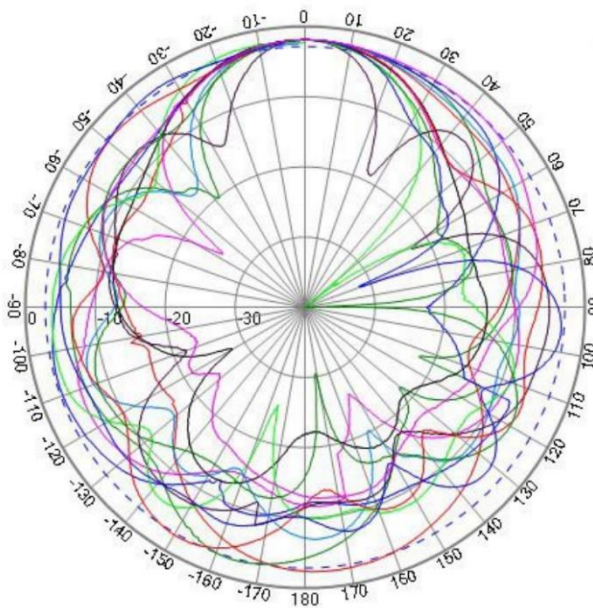

- Freq: 700
- Freq: 824
- Freq: 868
- Freq: 960
- Freq: 1710
- Freq: 1850
- Freq: 1990
- Freq: 2170
- Freq: 2300
- Freq: 2400
- Freq: 2500
- Freq: 2690

VSWR – VOLTAGE STANDING WAVE RATIO [-]

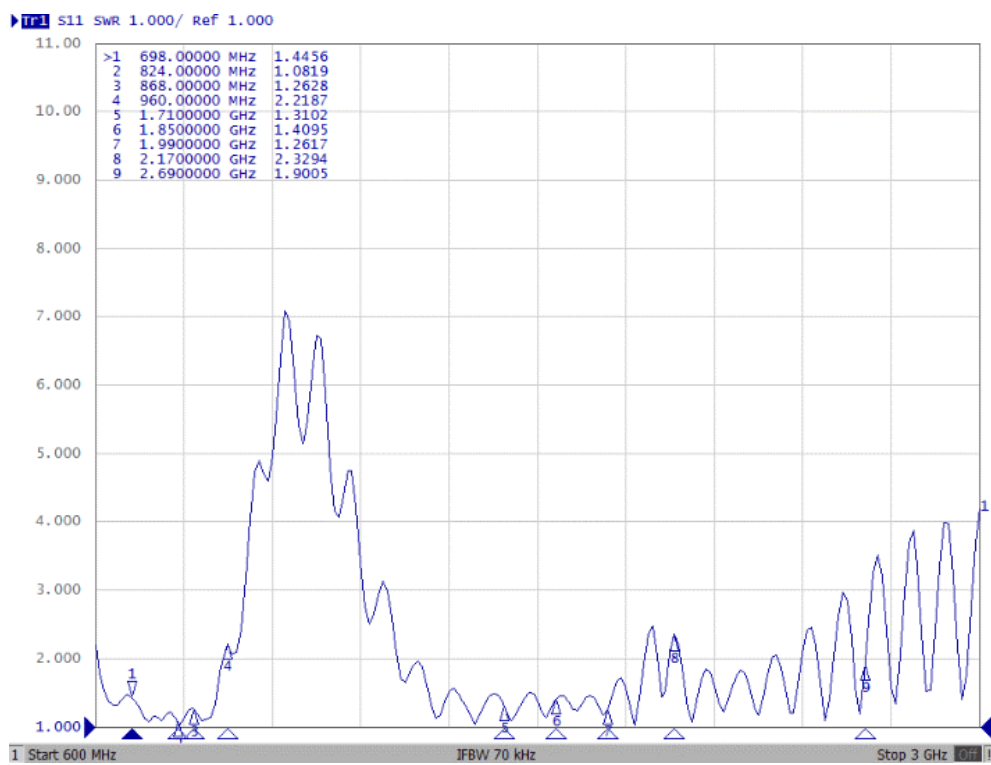

SUMMARY

Frequency (MHz)	Return Loss (dB)	VSWR
698	-14.56	1.46
868	-18.78	1.26
960	-8.43	2.22
1710	-17.45	1.31
2170	-7.97	2.33
2690	-10.16	1.90

VARIANTS

Different connector variants or cable lengths are available on request

CONTACTS

SECTRON s.r.o. Josefa Šavla 1271/12
709 00 Ostrava 9, Czech Republic

WWW.SECTRON.CZ
Tel.: +420 556 621 020