



LTE/GNSS/WiFi ANTENNA

Antenna LTE MIMO/GNSS/WiFi MIMO
Screw Mount E604,
5x RG174/3m, 5x SMA(m)

AO-AKOM-E604LMWM-5S

SECTRON company offers a wide portfolio of LTE/GNSS/WiFi antennas with various versions differing in shape, level of gain and manner of attachment. SECTRON guarantees a compatible connection between an antenna and all antenna adaptors produced by SECTRON.

BENEFITS

- MIMO antenna
- Wide range of used technologies



Technology	GSM/UMTS/LTE /Wi-Fi/GPS
Frequency bands	700/800/900/1700/1800/2100/2600 MHz 2.4/5 GHz 1574.42/1602 MHz
Bandwidth	-
LTE/WiFi/GNSS Gain	3/2/0 dBi
LNA Gain	28 dB
VSWR	<3.0:1/<2.5:1/<2.0:1
Impedance	50 Ohm
Directivity	Omnidirectional
Beam angle	See attached graphs bellow
Polarization	Linear/Linear/R.H.C.P
Maximum input power	10 W
Power voltage	3 – 5 V
Dimensions	Ø110 x 55 mm
Weight	523.45 g
Operating temperature	-20 to +60 °C
Execution	External
Method of attachment	Screw Mount
Cable type	5 x RG174/U
The cable length	5 x 3 m
Connector type	5 x SMA(m)
IP Code	IP67

DRAWING

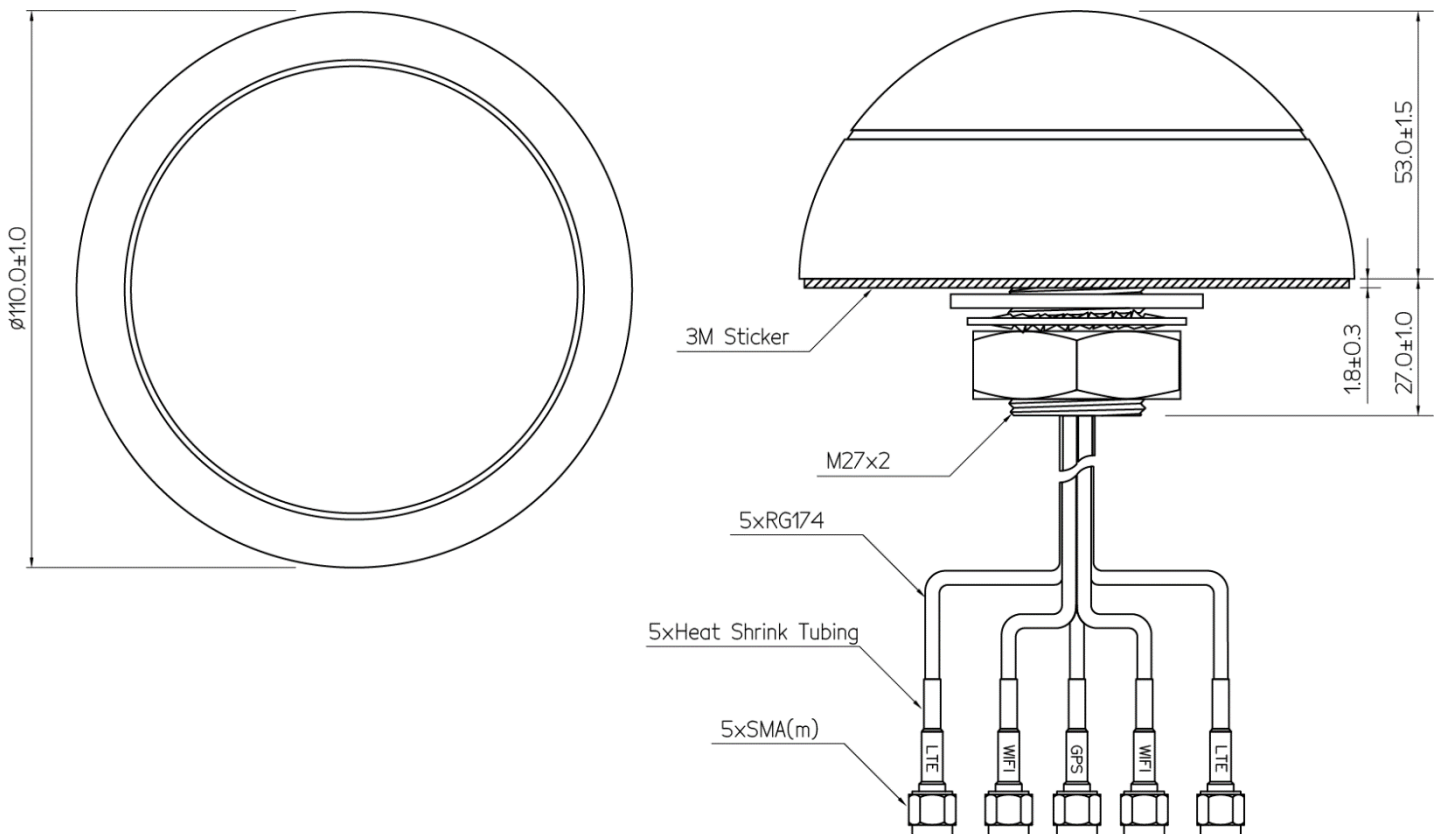

Radiation pattern - GNSS

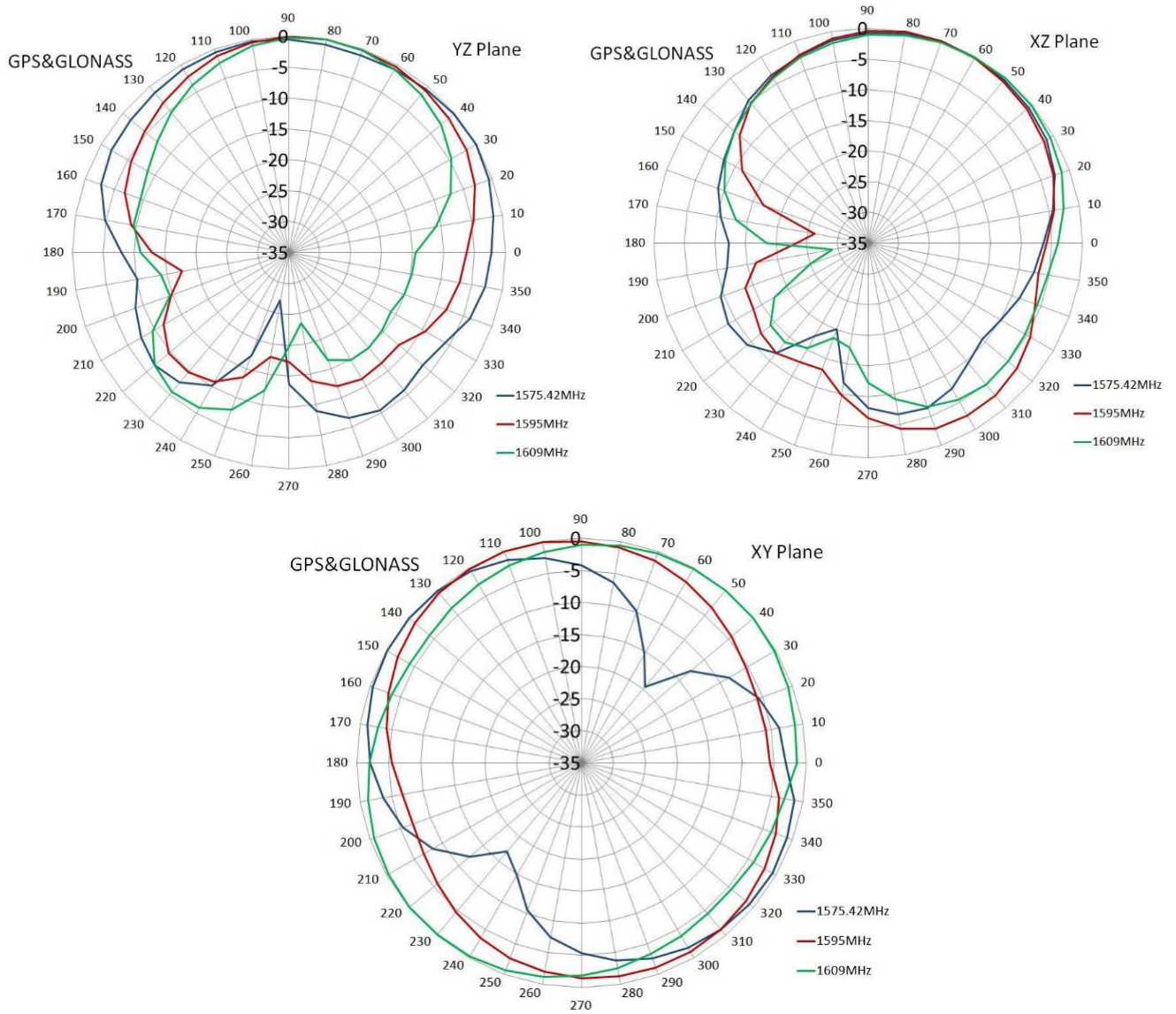

Graph – S11

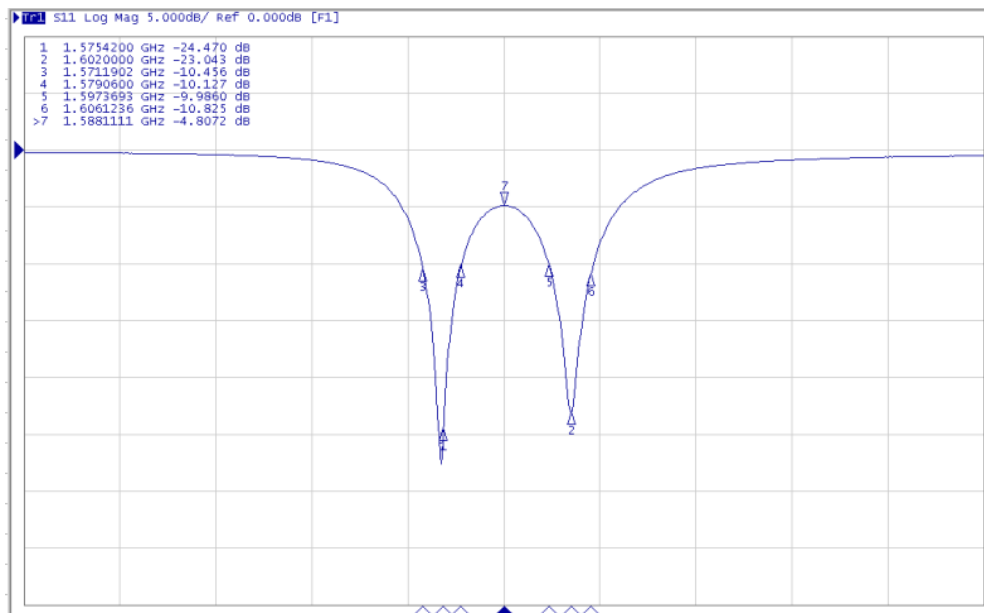

Radiation pattern - Cellular

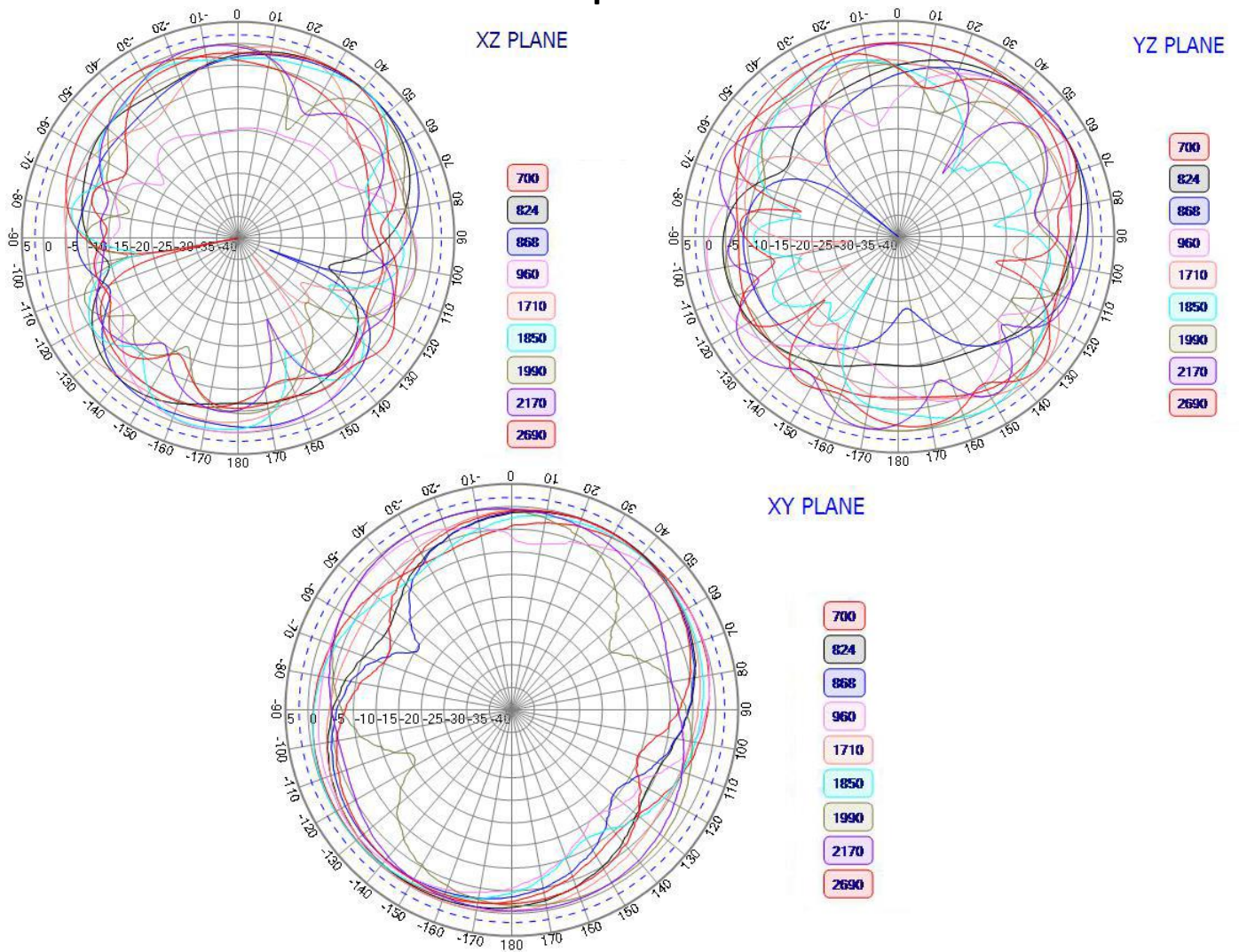

Graph – S11

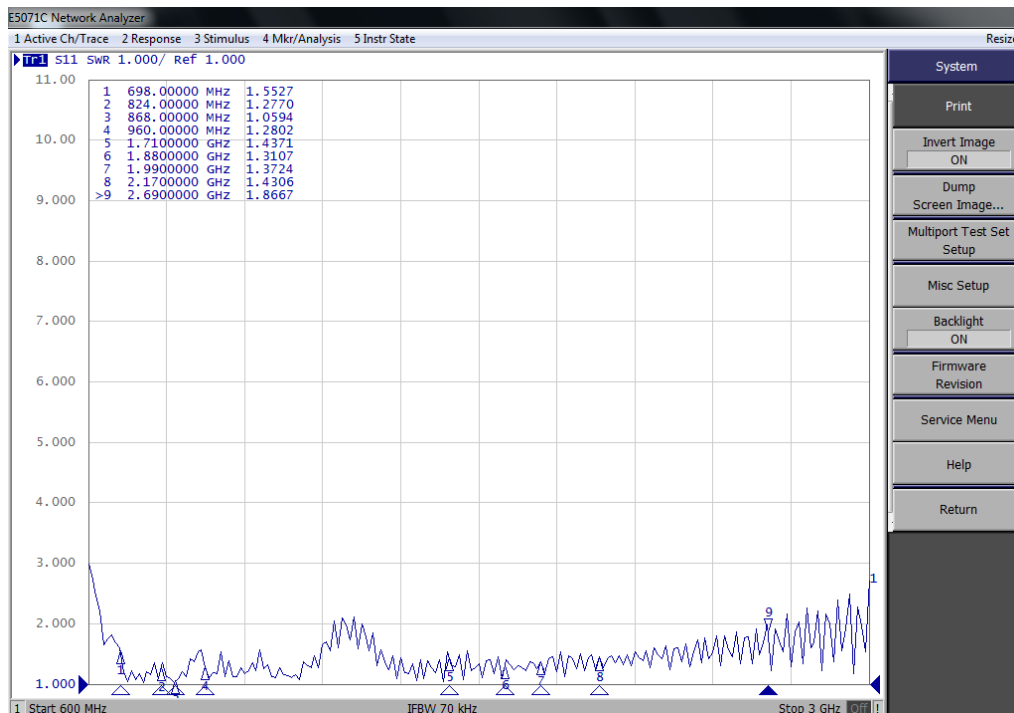

Radiation pattern - WiFi

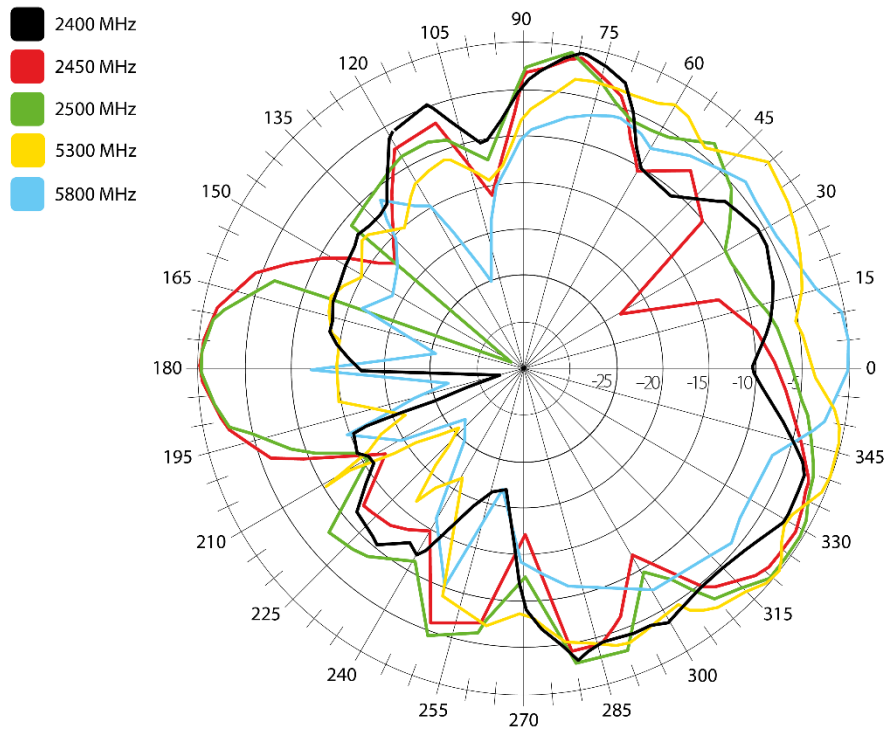
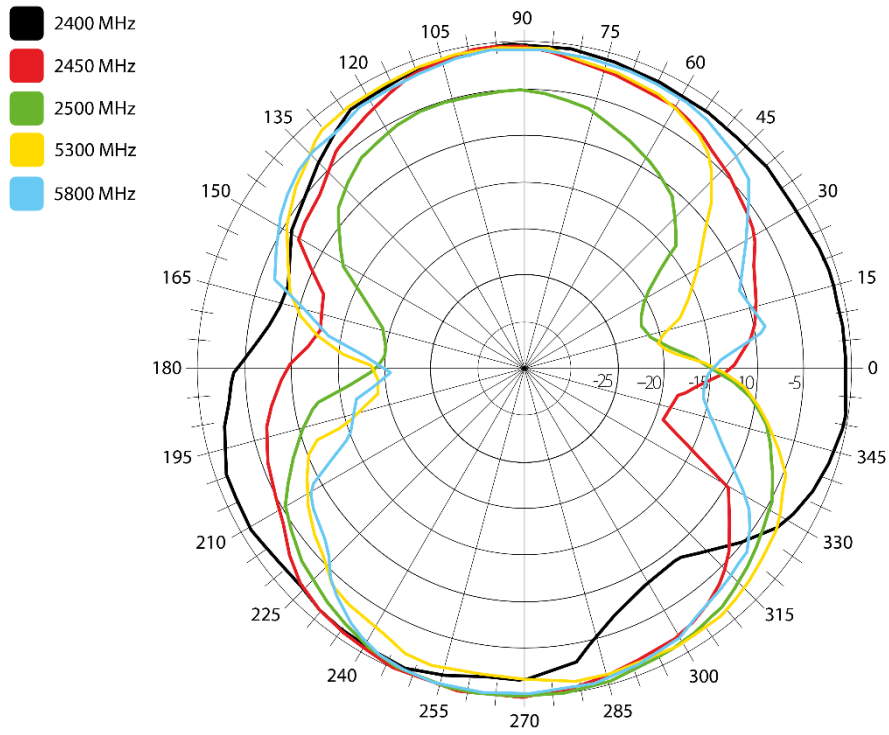

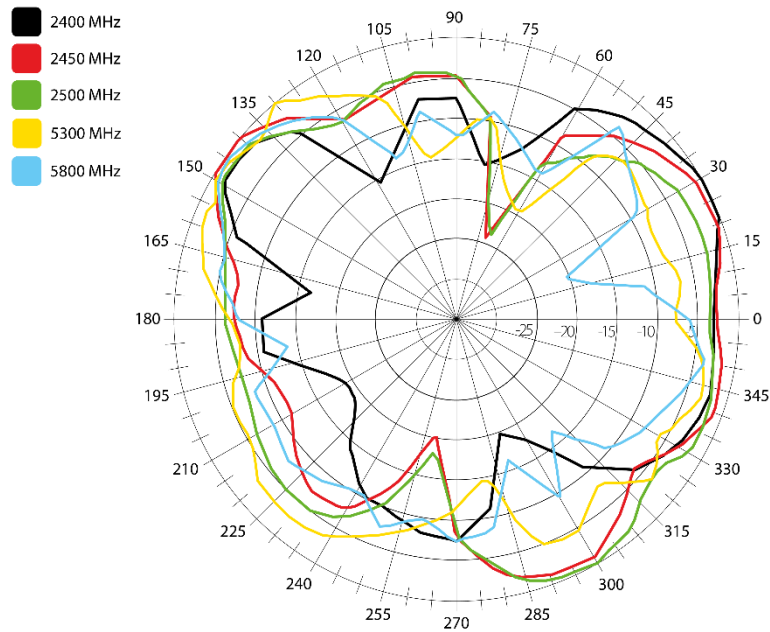

Graph – VSWR

