



## LTE/GPS/WIFI ANTENNA

Antenna LTE/GPS/WIFI MIMO

Screw mount E072, 4x FAKRA(f),  
4x .100/4.5m

AO-AKOM-E072LGWM-4F

SECTRON company offers a wide portfolio of LTE/GPS/WIFI antennas with various versions differing in shape, level of gain and manner of attachment. SECTRON guarantees a compatible connection between an antenna and all antenna adaptors produced by SECTRON.



### BENEFITS

- IP67
- Low VSWR
- Anti-vandal design
- High frequency range (wide band antenna)

Technology	GPS/LTE/WIFI
Frequency bands	698-960/ 1575.42±3/ 1710-2690/2400-2483 MHz
Bandwidth	-
Gain	2/3.5/3 dBi
LNA gain	28 dB
VSWR	<1.5:1/<2.0:1/<3.0:1
Impedance	50 Ohm
Directivity	Directional (GPS)/Omnidirectional (LTE/WIFI)
Beam angle	Attached graphs below
Polarization	R.H.C.P/Linear/Linear
Maximum input power	10 W
Power voltage	3-5V DC (GPS)
Dimensions	181.7 x 69.1 x 68.9 mm
Weight	-
Operating temperature	-40 to +85 °C
Execution	External
Method of attachment	Screw mount
Cable type	4x .100
The cable length	4x 4.5 m
Connector type	4x FAKRA(f)
IP code	IP67
Certification	RoHS

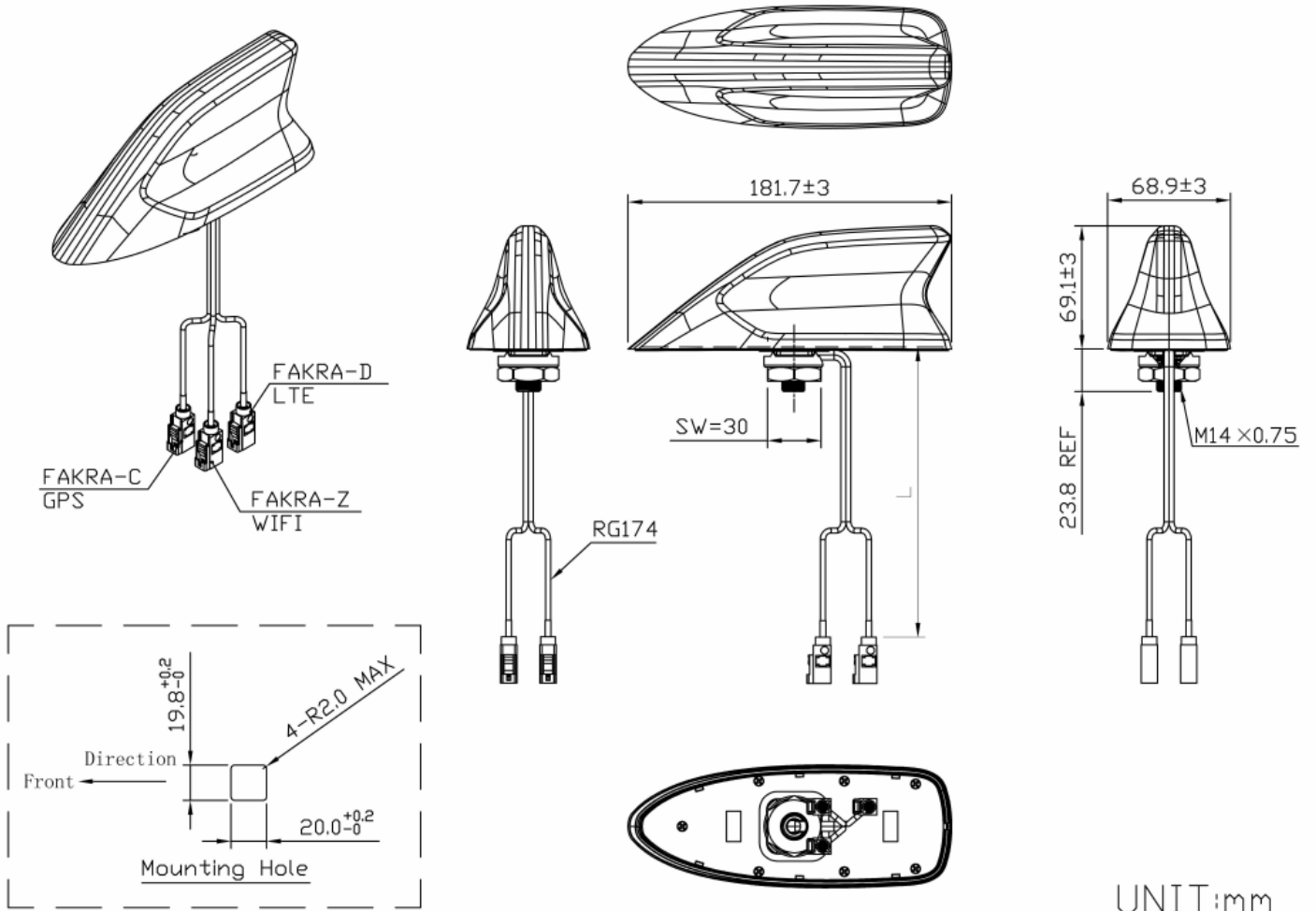

UNIT:mm

$S_{11}$  [dB] – RETURN LOSS

## VSWR– STANDING WAVE RATIO [-]

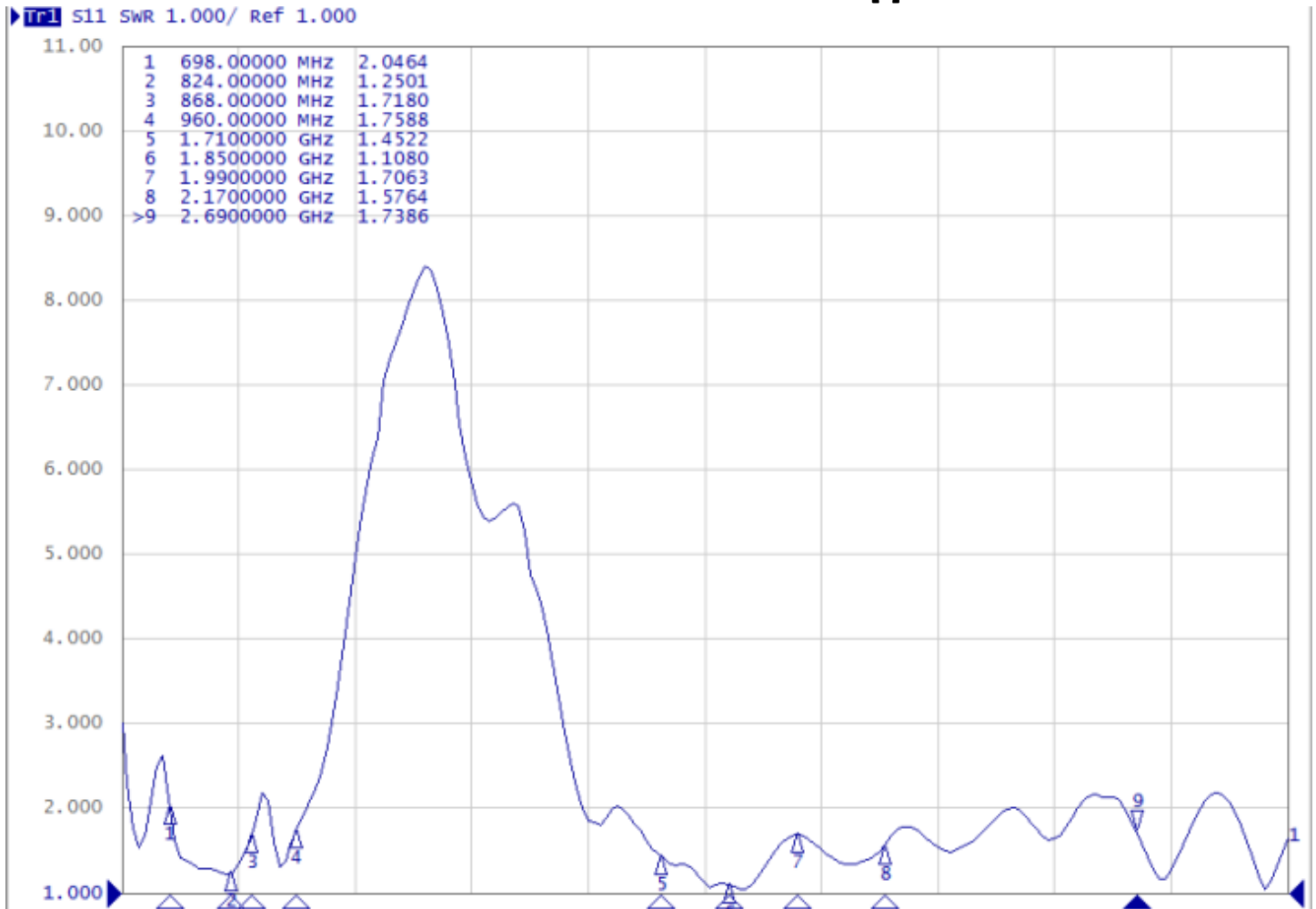

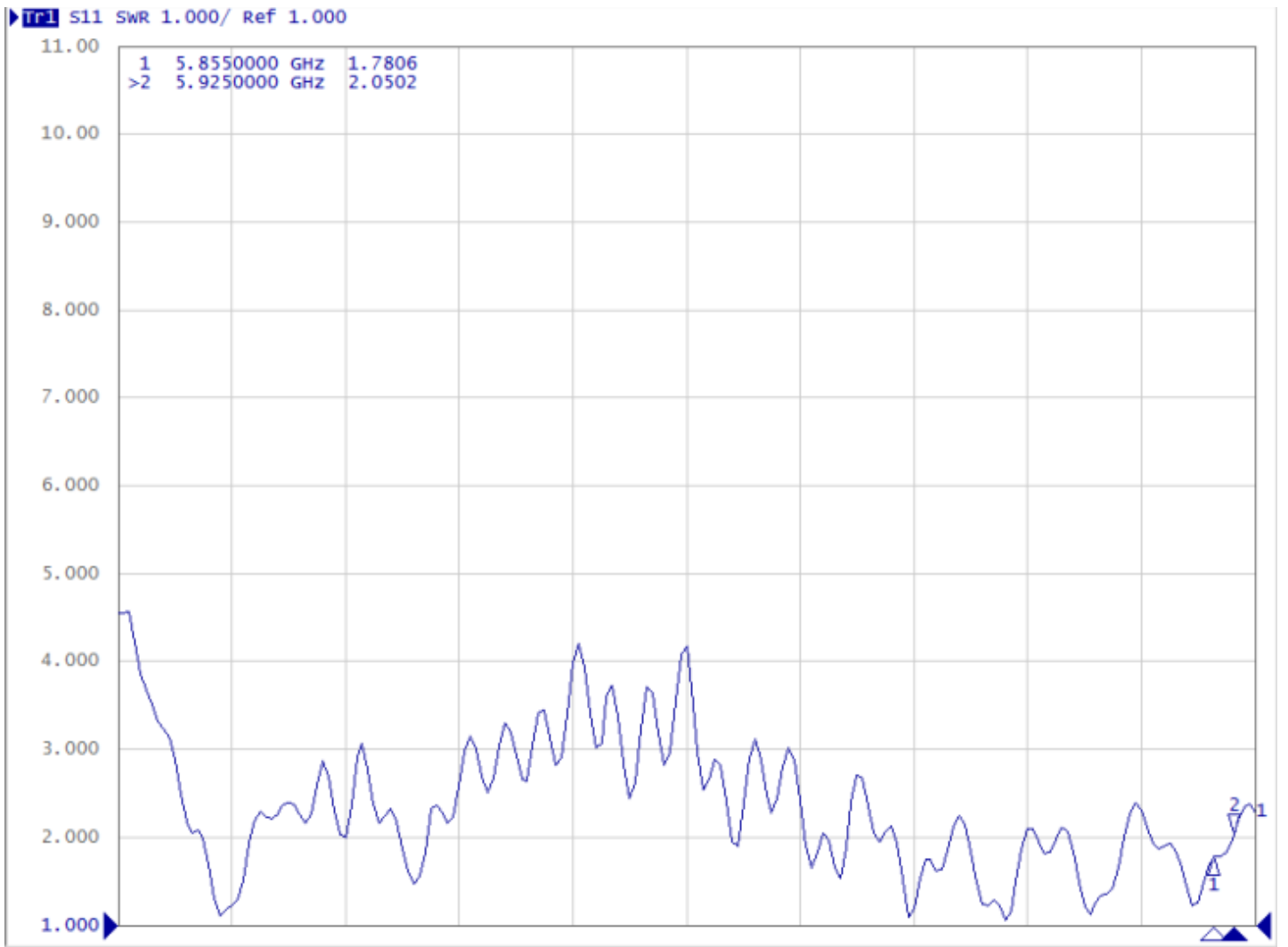

SIMULATED GRAPHS

AO-AKOM-E072LGWM-4F

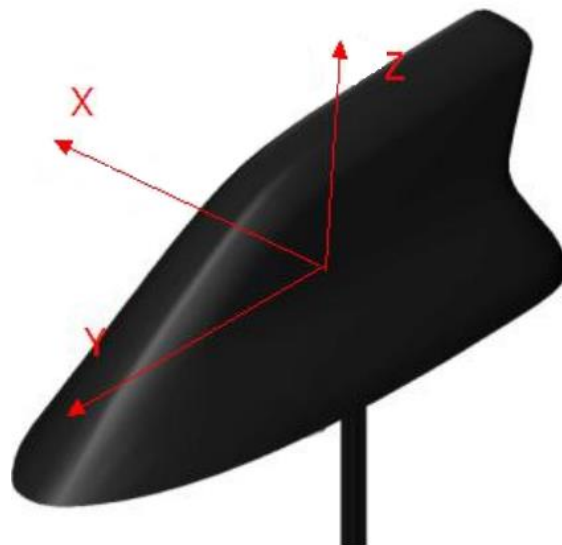

### RADIATION PATTERN – GPS

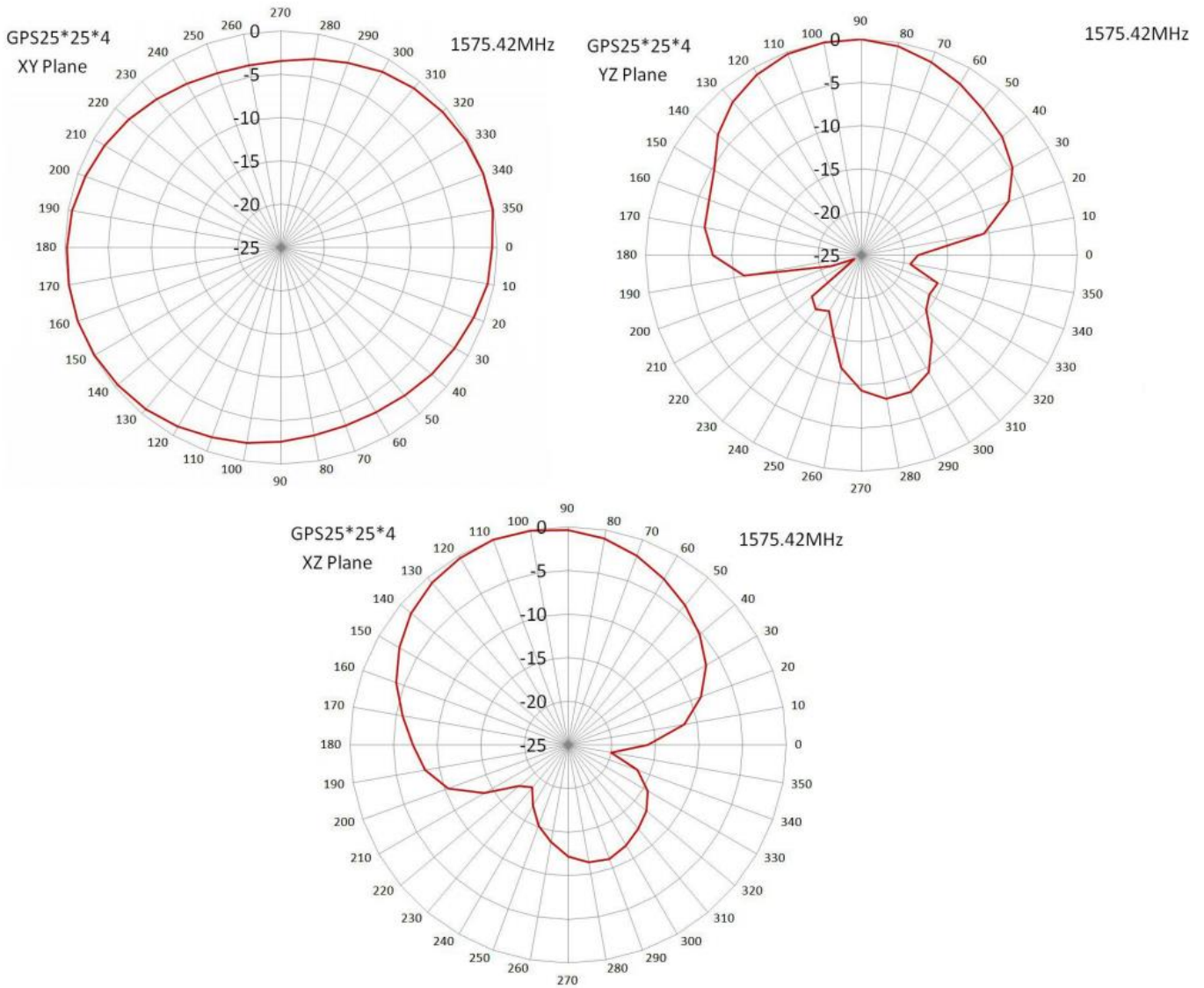

### RADIATION PATTERN – LTE + WIFI

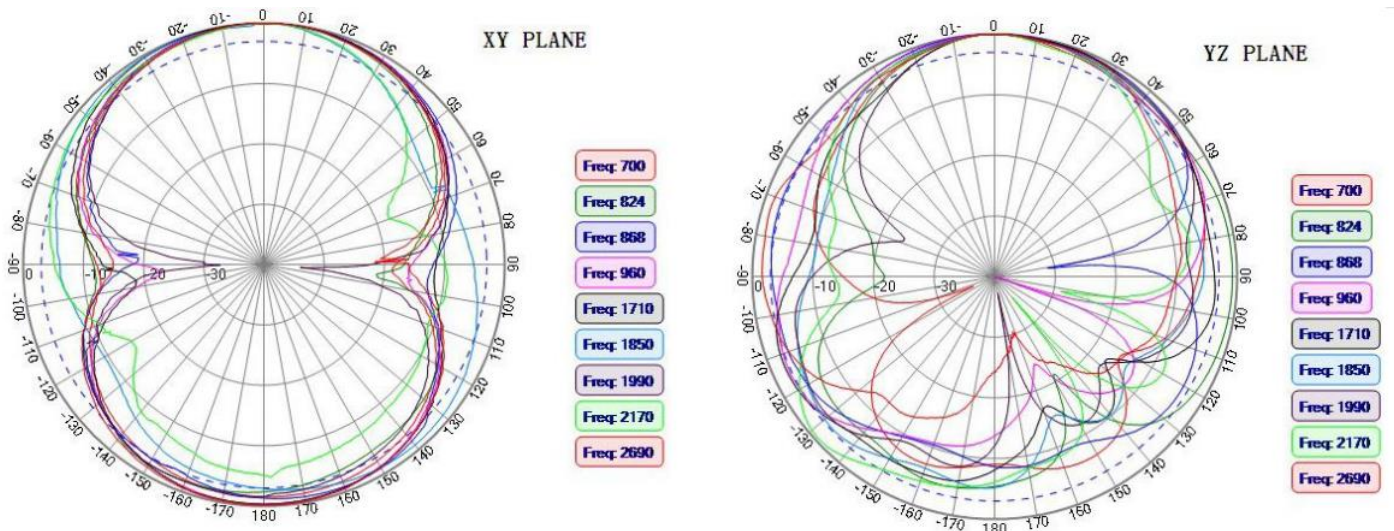

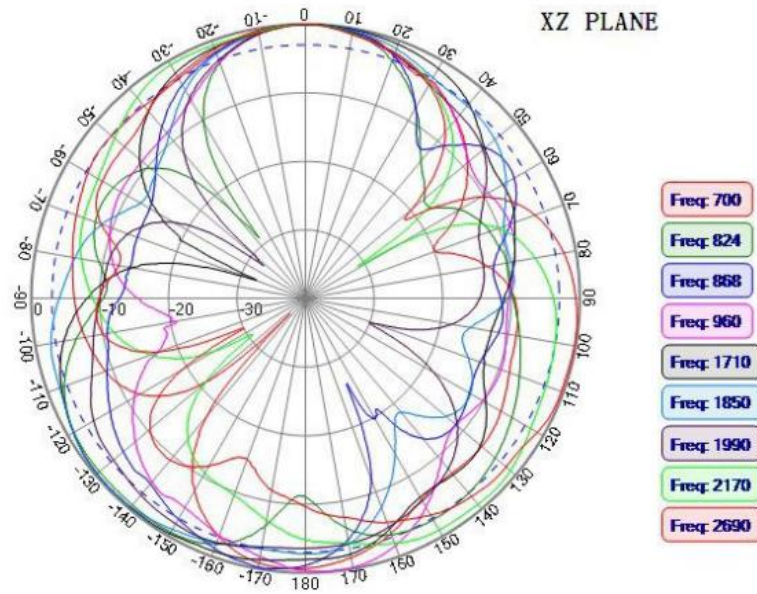

## CONTACTS

SECTRON s.r.o. Josefa Šavla 1271/12  
709 00 Ostrava 9, Czech Republic

WWW.SECTRON.CZ  
Tel.: +420 556 621 020