



GPS/LTE/Wi-Fi Antenna

Antenna GPS/LTE/WIFI Screw
Mount 008,3x RG174 160 cm,
2x SMA(m), 1x SMA-RP-Wi-Fi

AO-AKOM-E008SSSRP

SECTRON company offers a wide portfolio of GPS/LTE/Wi-Fi antennas with various versions differing in shape, level of gain and manner of attachment. SECTRON guarantees a compatible connection between an antenna and all antenna adaptors produced by SECTRON.

BENEFITS

- Low VSWR
- Anti-vandal design
- Optimized radiation pattern



FEATURES

AO-AKOM-E008SSSRP

Technology	GPS/LTE/Wi-Fi
Frequency bands	1575.42/ 698-960/ 1710-2690/ 2400-2483.5/ 4900-5825 MHz
Bandwidth	CF ± 5 MHz (GPS)
Gain	2/2/3 dBi
LNA Gain	28 \pm 2 dBi
VSWR	<1.5:1/<2:1/<2:1
Impedance	50 Ohm
Directivity	Directional/Omnidirectional/Omnidirectional
Beam angle	Attached graphs bellow
Polarization	R.H.C.P./Linear/Linear
Maximum input power	10 W
Power voltage	2.2-5 VDC
Dimensions	\varnothing 81.3 x 31.3 mm
Weight	- g
Operating temperature	-40 $^{\circ}$ C~+85 $^{\circ}$ C
Execution	External
Method of attachment	Screw mount
Cable type	RG174/U
The cable length	1.6 m
Connector type	SMA(m)/SMA(m)/SMA-RP(f-pin)
Certification	RoHS
IP code	IP66
Material	ABS

DRAWING

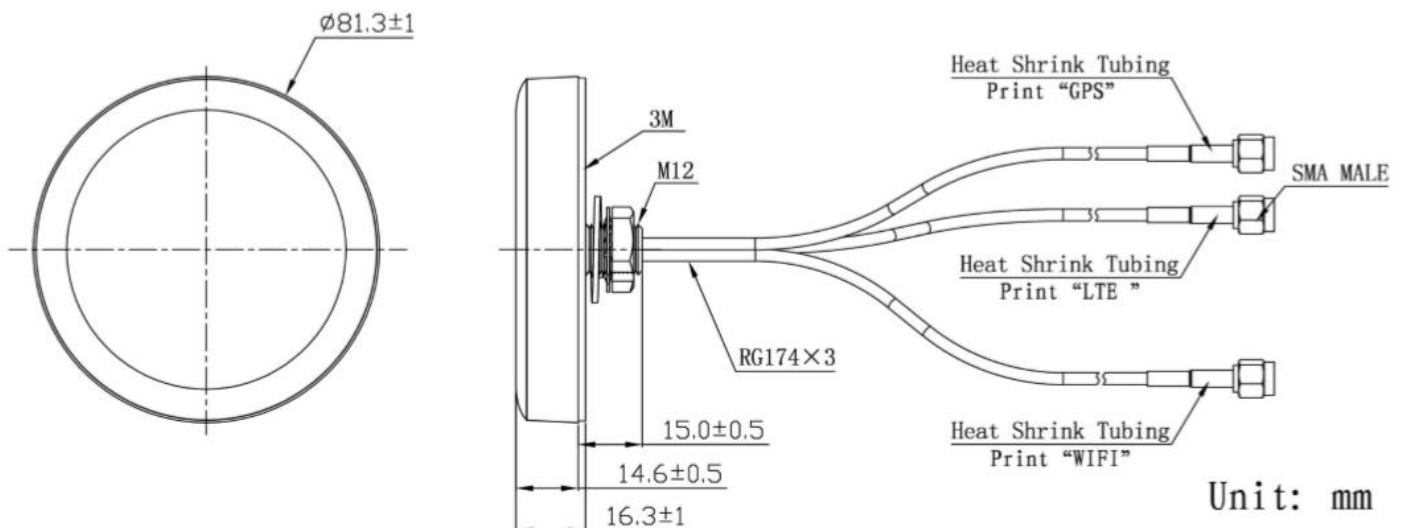

RADIATION PATTERN – GPS

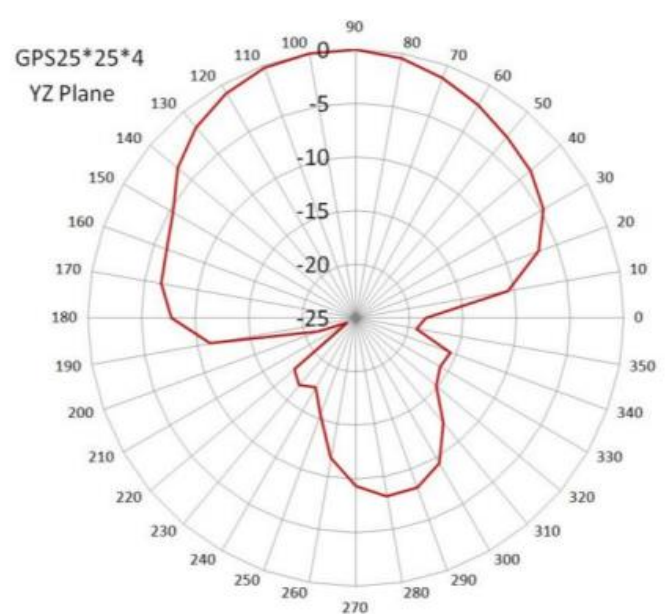
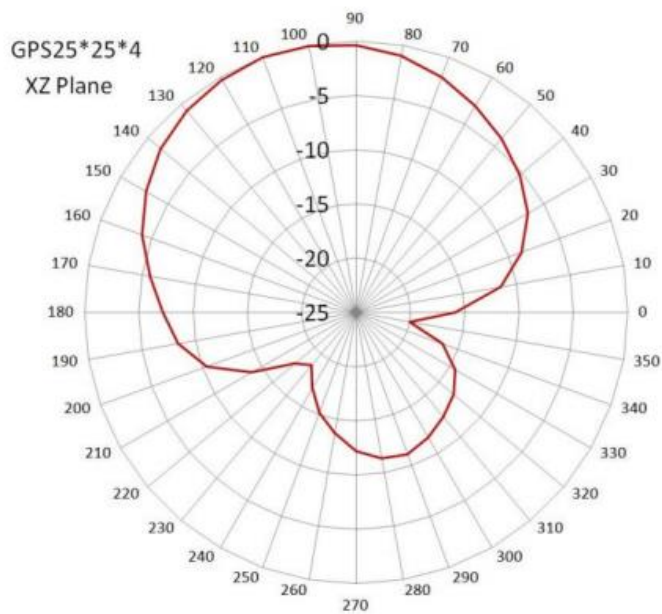
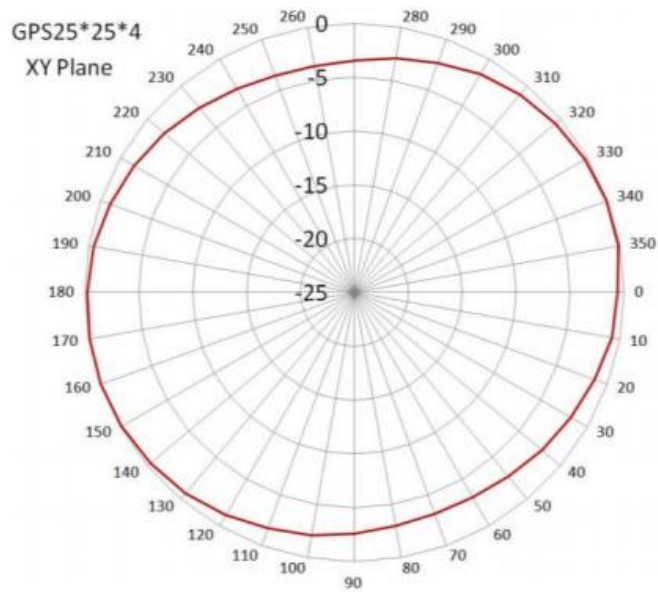

RADIATION PATTERN – LTE

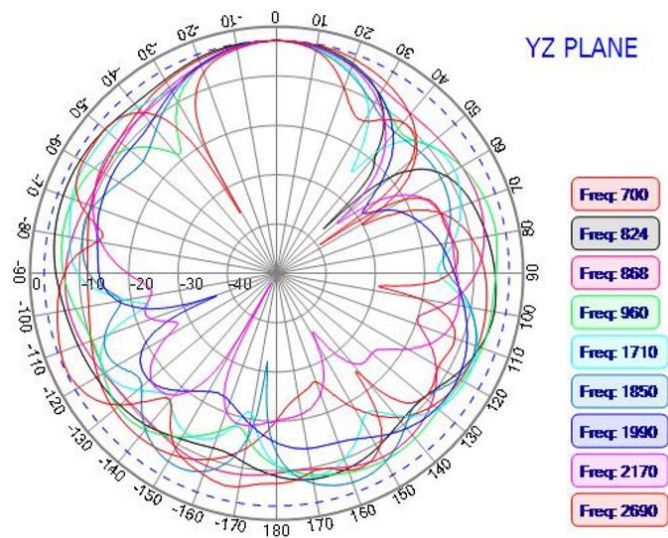
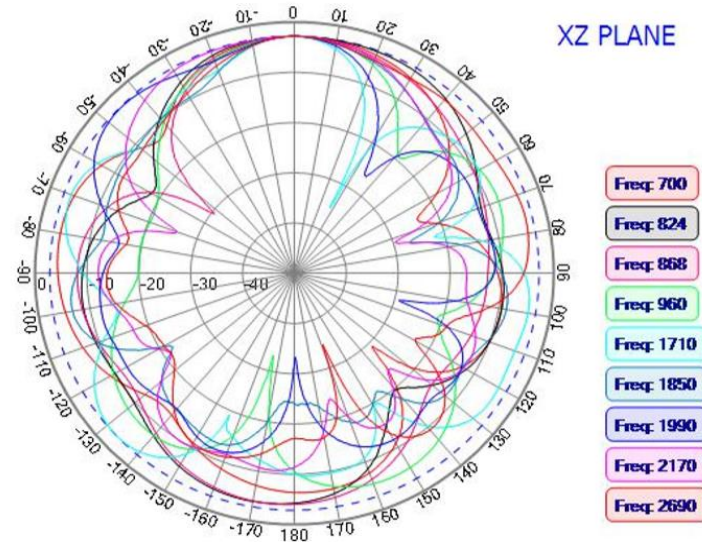
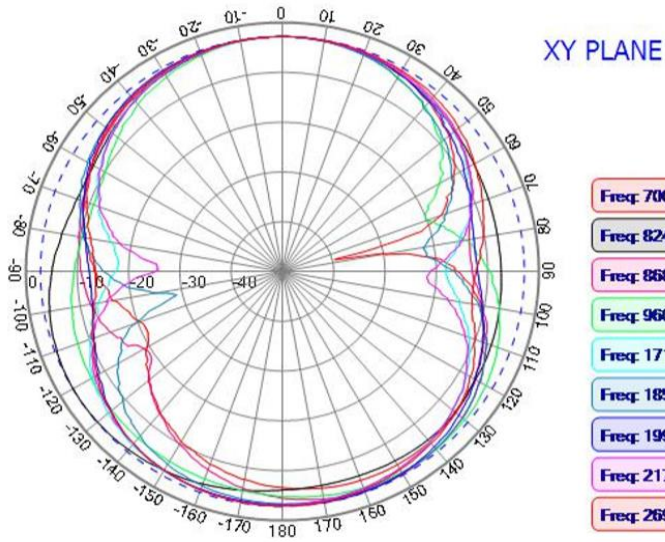

RADIATION PATTERN – WiFi

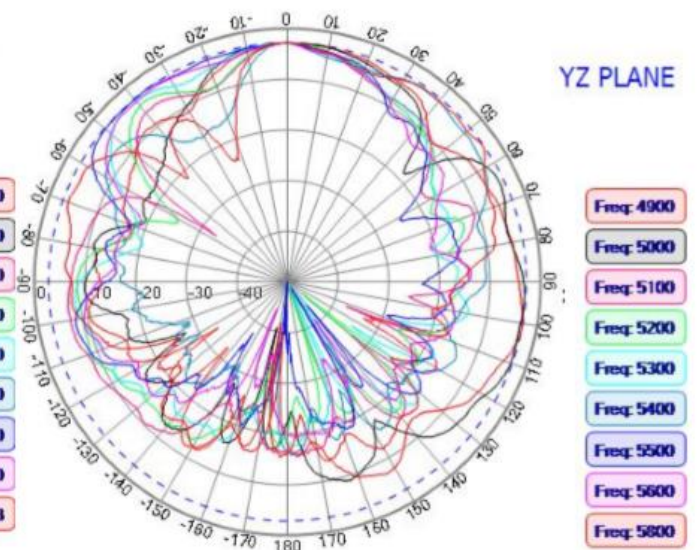
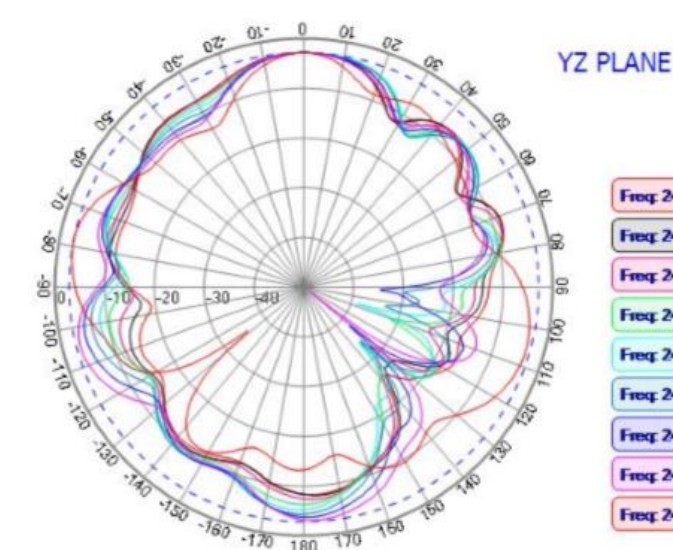
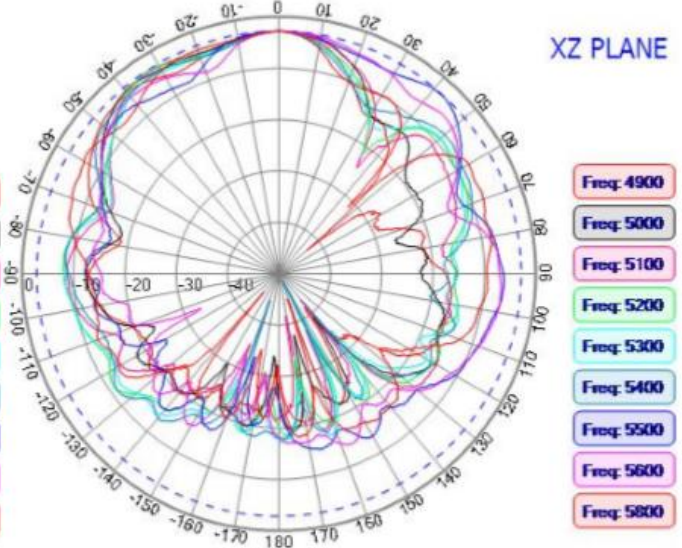
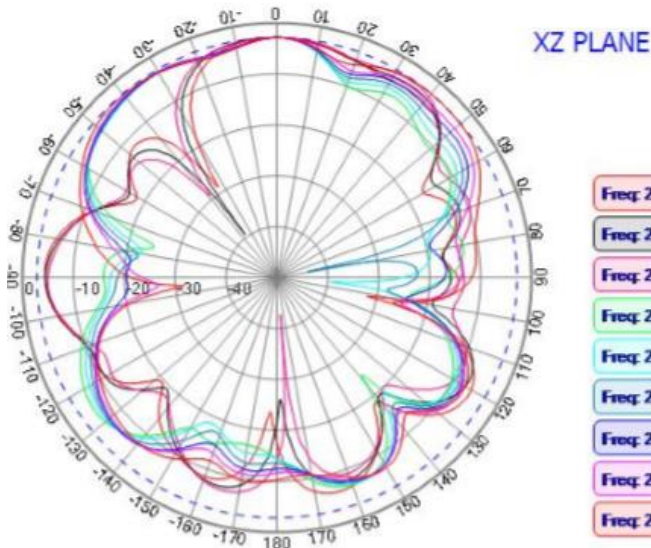
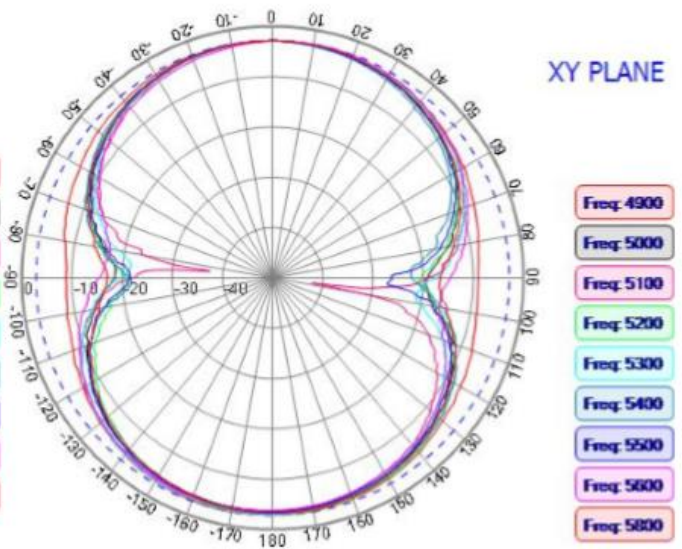
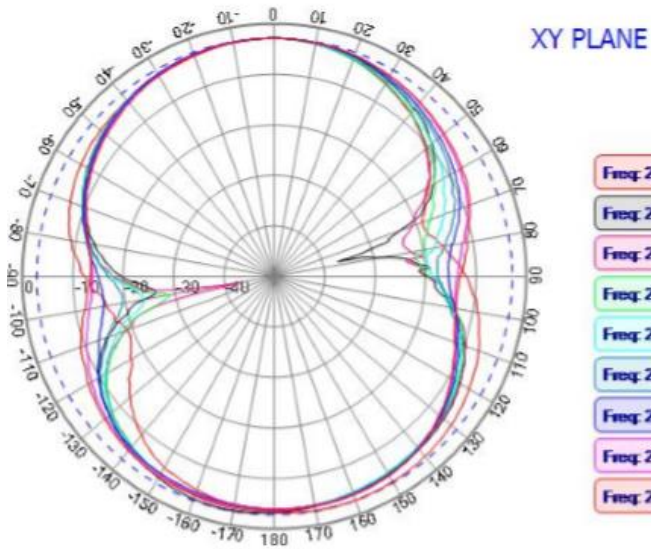

S11 - RETURN LOSS [dB]

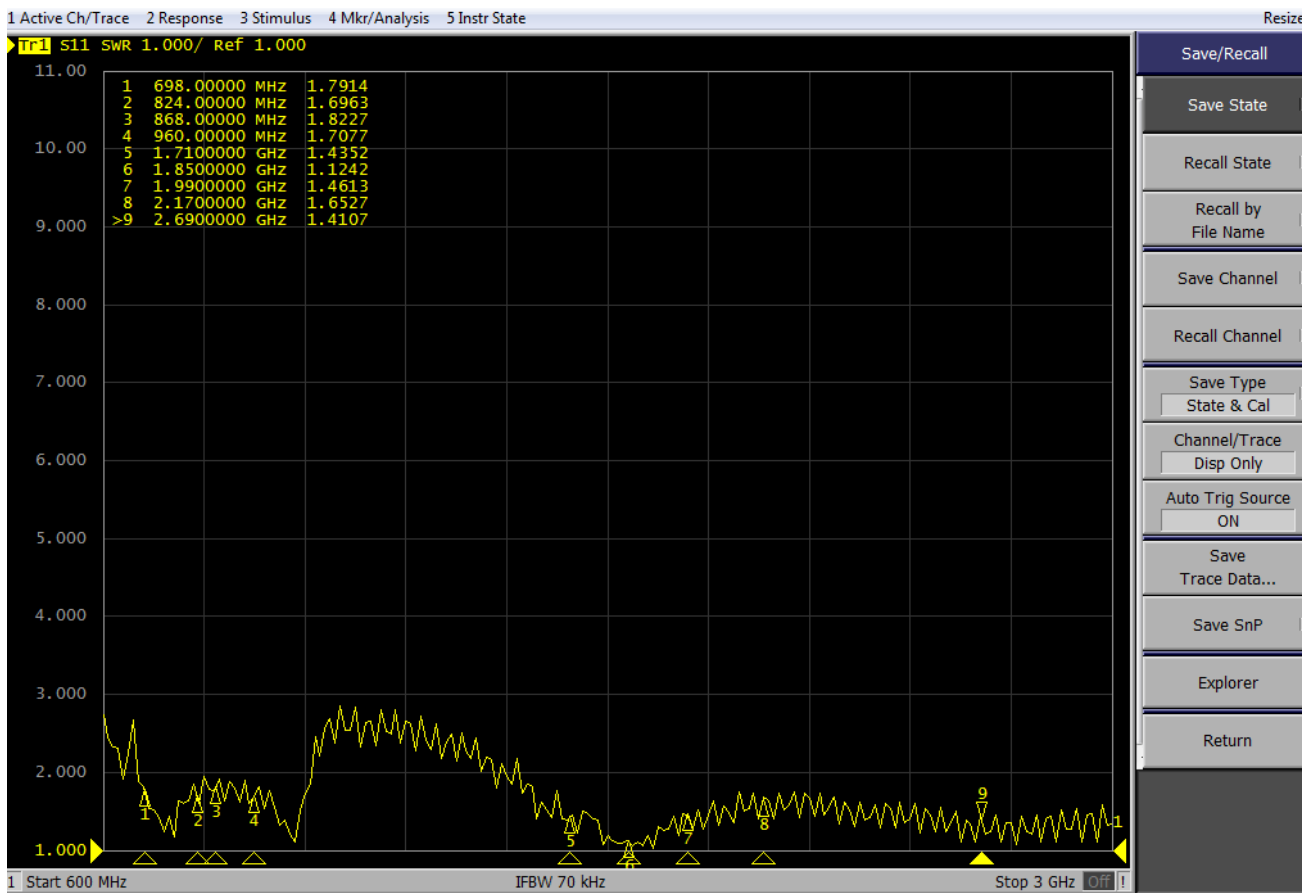

S11-RETURN LOSS [dB] & VSWR – STANDING WAVE RATIO [-]

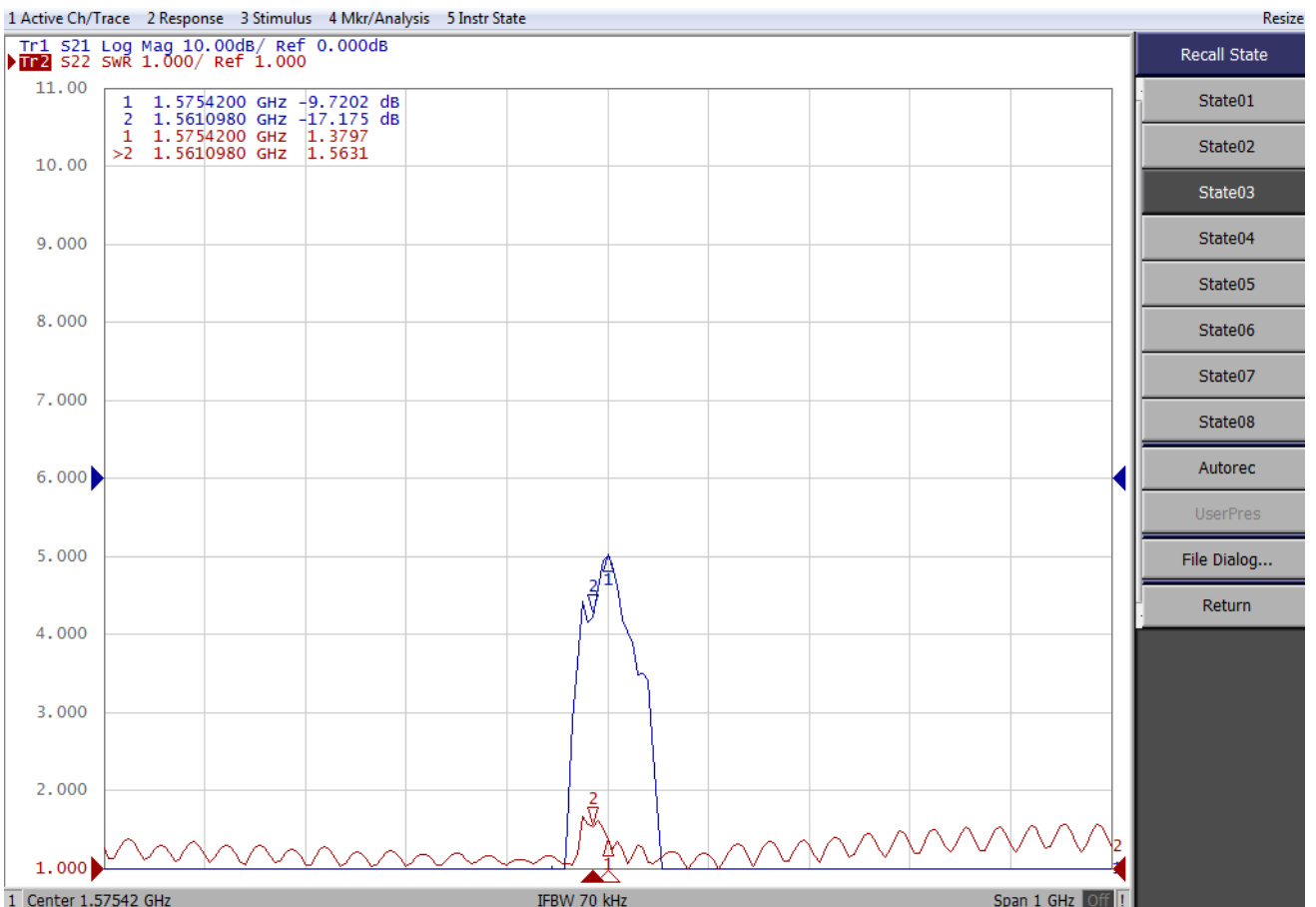

MEASURED GAIN GSM/UMTS/LTE bands:

Frequency [MHz]	Gain [dBi]
700	1.03
824	2.83
868	2.81
960	1.67
1710	-3.94
1850	-1.42
1990	0.44
2170	2.2
2690	0.95

MEASURED GAIN GPS:

Frequency [MHz]	Gain [dBi]
1575.42	28.20

VARIANTS

Different connector variants or cable lengths are available on request

CONTACTS

SECTRON s.r.o. Josefa Šavla 1271/12
709 00 Ostrava 9, Czech Republic

WWW.SECTRON.CZ
Tel.: +420 556 621 020