



GSM/UMTS ANTENNA

Antenna GSM/UMTS Stick 90/180,
Penta-band, 2 dBi, SMA(m)

AO-AGSM-TG09

SECTRON company offers a wide portfolio of GSM/UMTS antennas with various versions differing in shape, level of gain and manner of attachment. SECTRON guarantees a compatible connection between an antenna and all antenna adaptors produced by SECTRON.



BENEFITS

- Low VSWR
- Adjustable angle
- No cable required

Technology	GSM/UMTS/LTE
Frequency bands	800/900/1800/1900/2100 MHz
Bandwidth	-
Gain	2 dBi
VSWR	<2.0:1
Impedance	50 Ohm
Directivity	Omnidirectional
Beam angle	Via attached graphs below
Polarization	Linear
Maximum input power	10 W
Power voltage	-
Dimensions	90°: 50 x 30 x 10; 180°: Ø 10 x 71.5 mm
Weight	8.48 g
Operating temperature	-20 to +60 °C
Execution	External
Method of attachment	Connector Mount
Cable type	-
The cable length	-
Connector type	SMA(m)

DRAWING

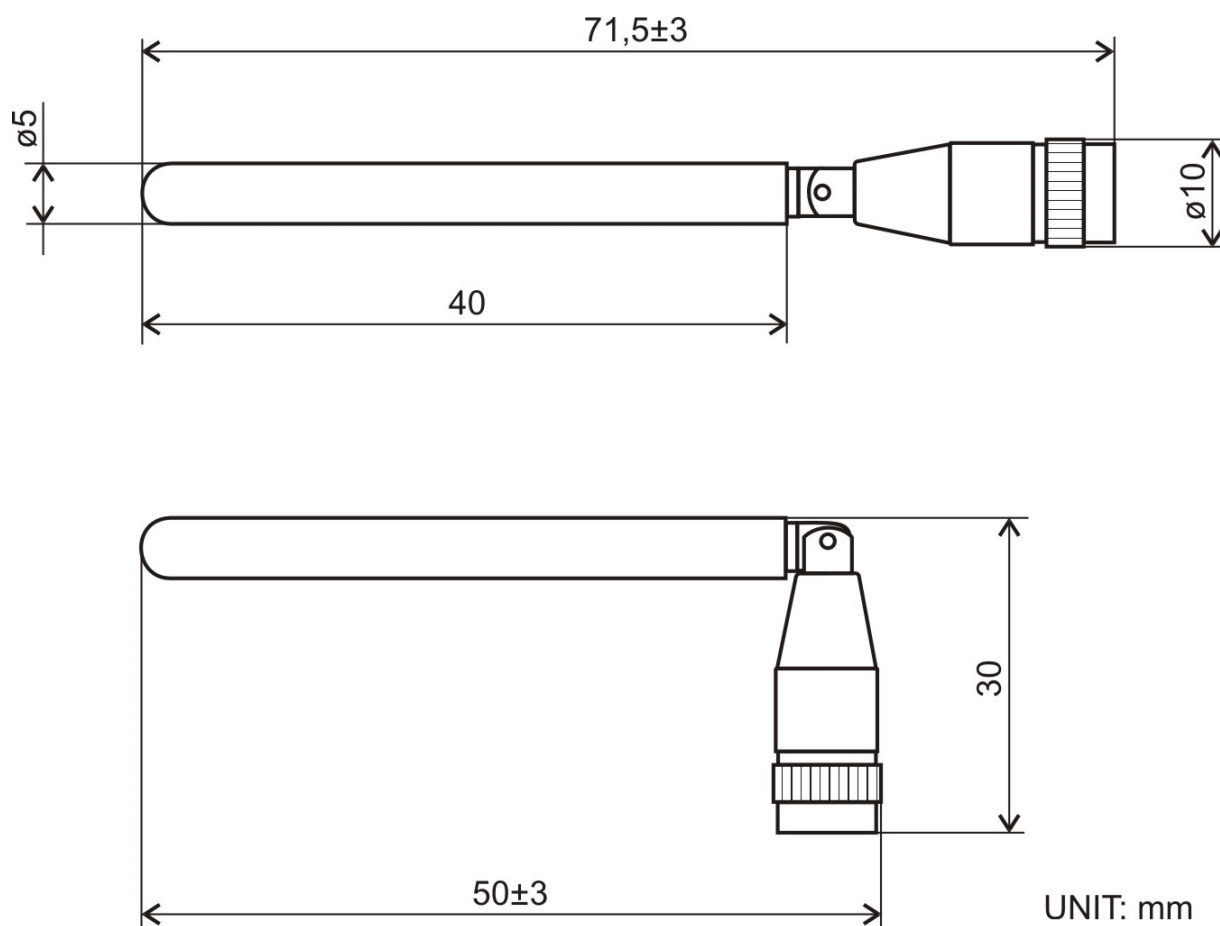

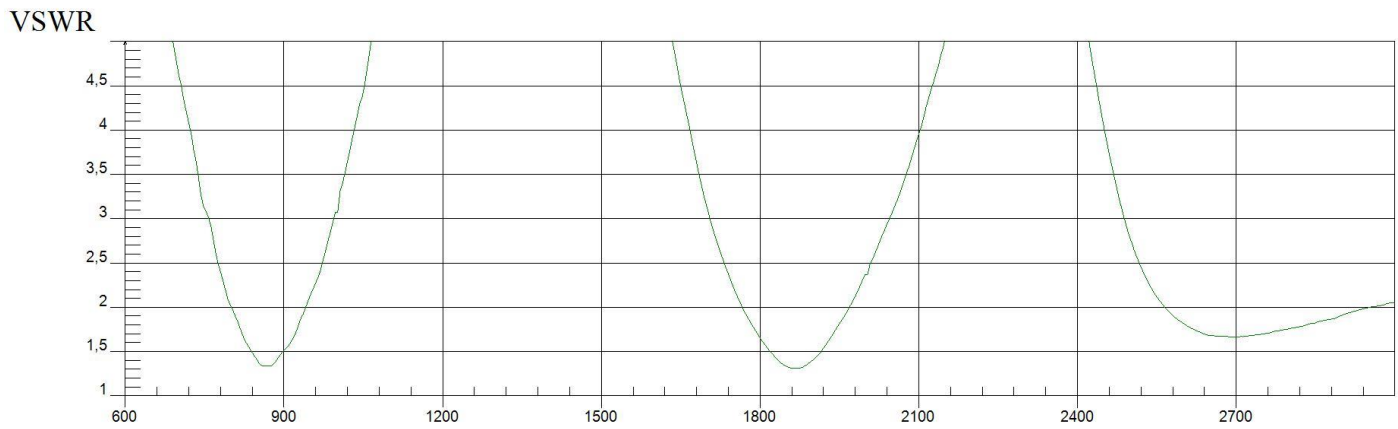
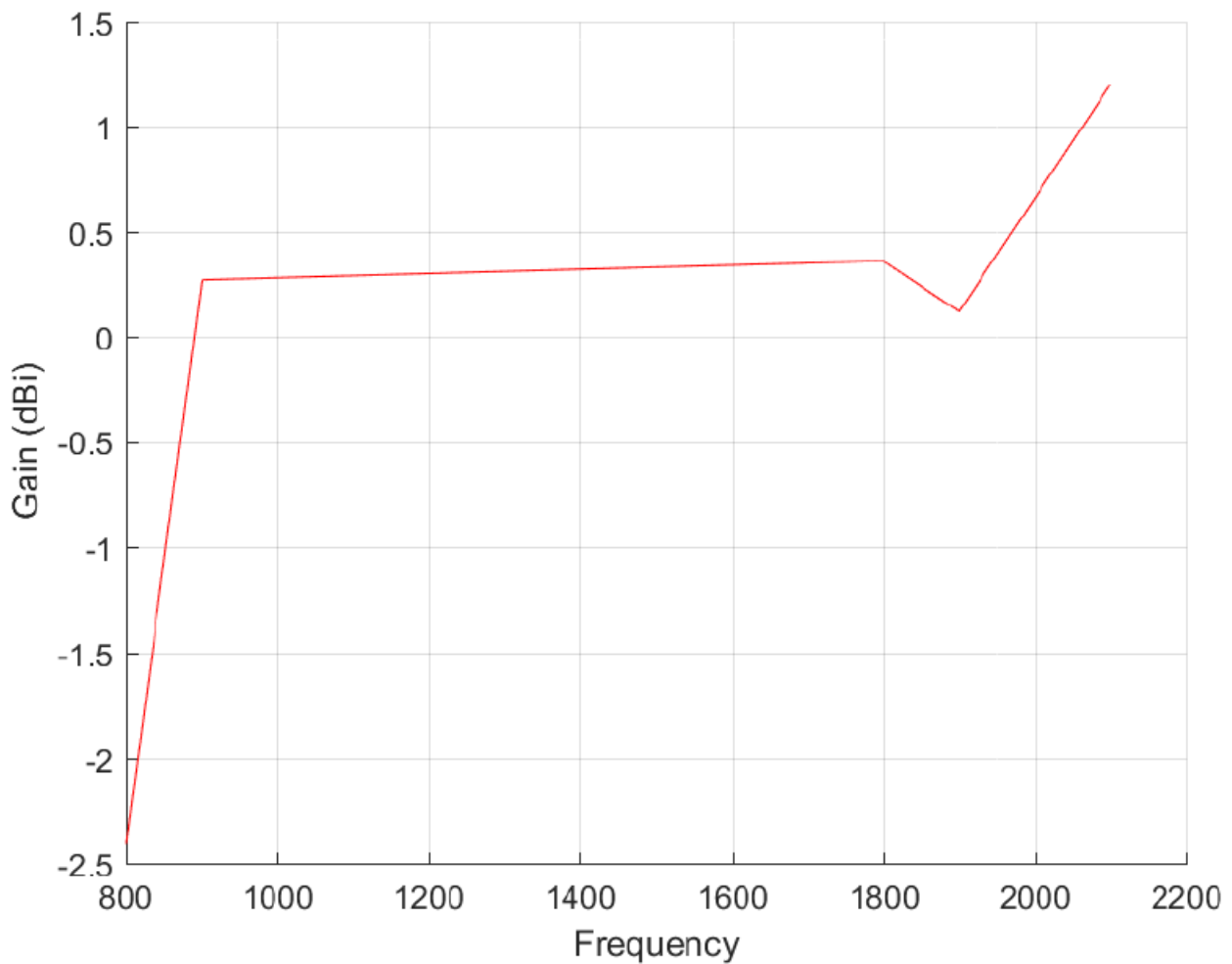
VSWR – Standing wave ratio [-]VSWR
AO-AGSM-TG09**Maximum Gain over Frequency [dBi]**

3D Radiation pattern

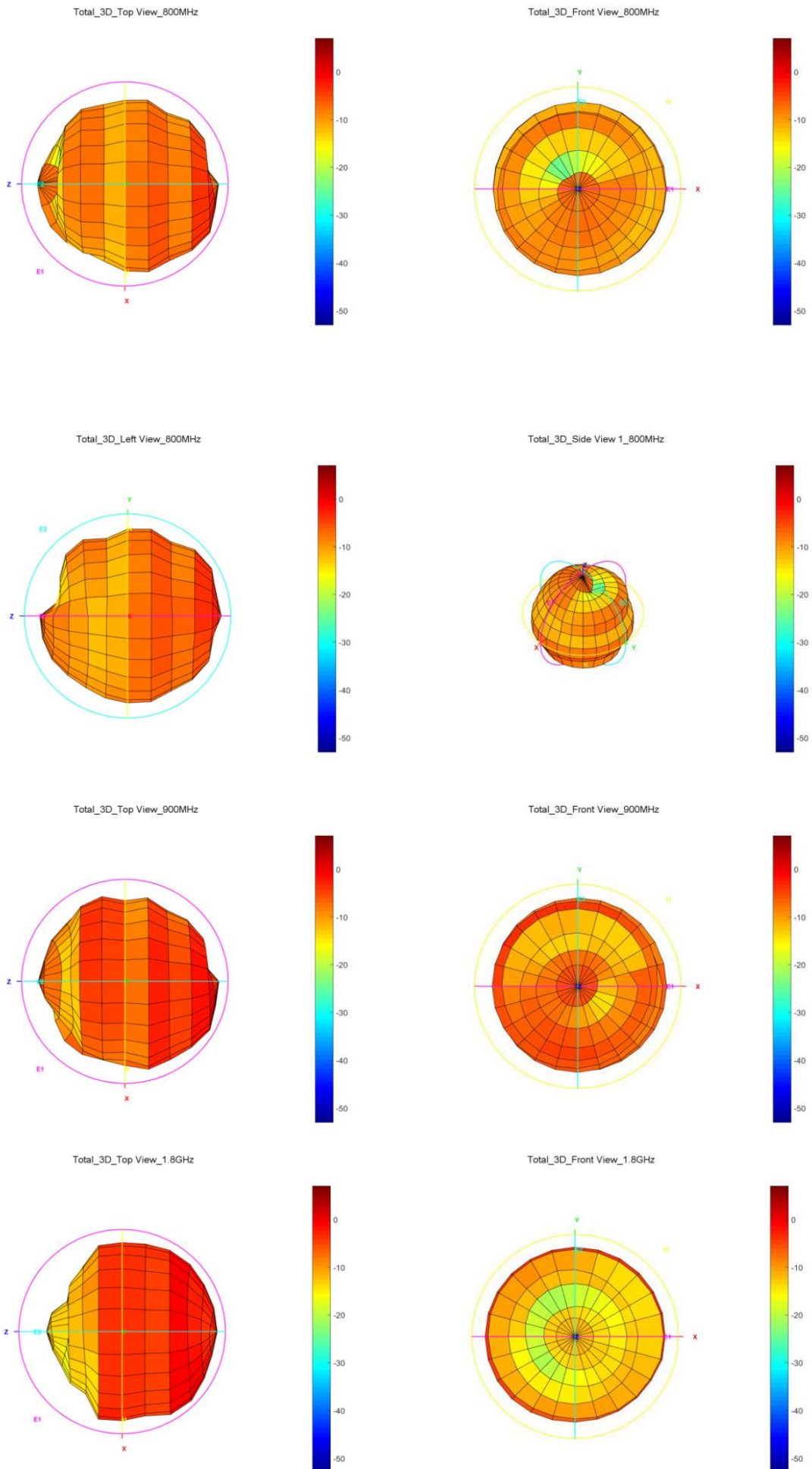

Total_3D_Left View_1.8GHz

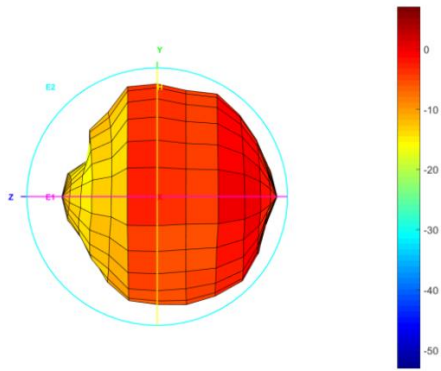

Total_3D_Side View_1.8GHz

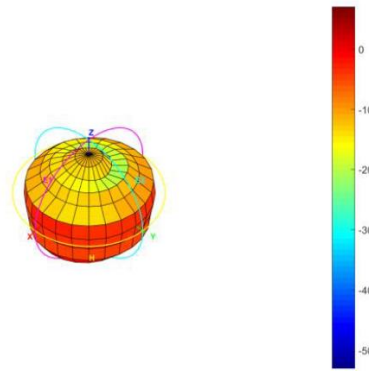

Total_3D_Top View_1.9GHz

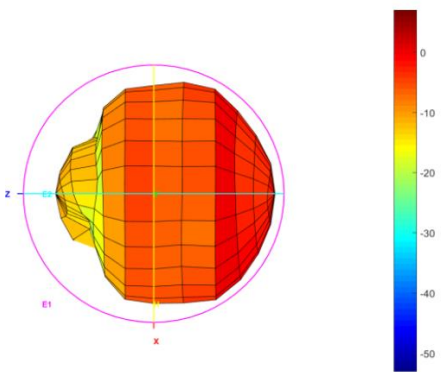

Total_3D_Front View_1.9GHz

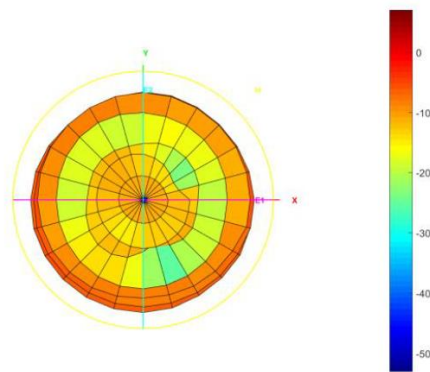

Total_3D_Left View_1.9GHz

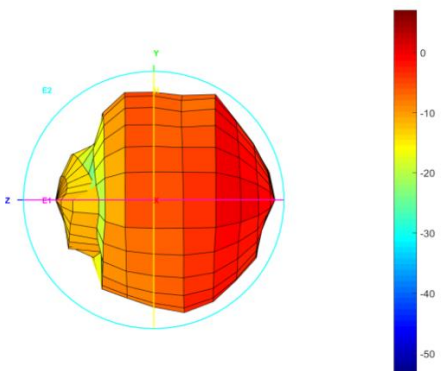

Total_3D_Side View_1.9GHz

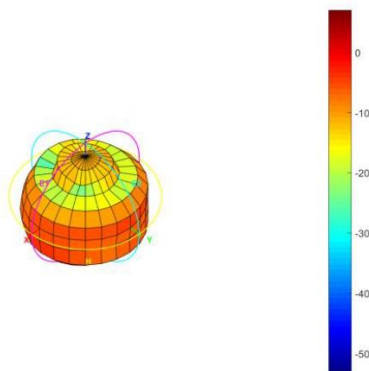

Total_3D_Top View_2.1GHz

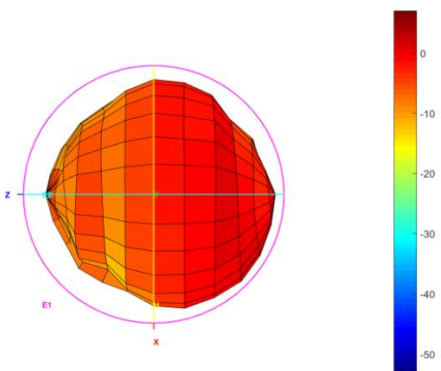

Total_3D_Front View_2.1GHz

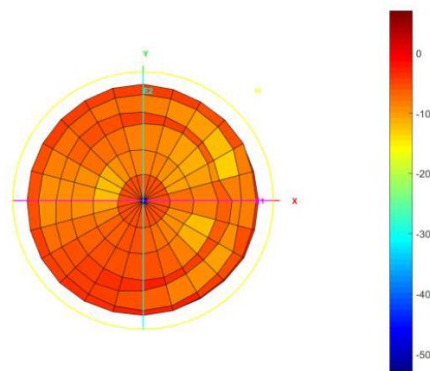

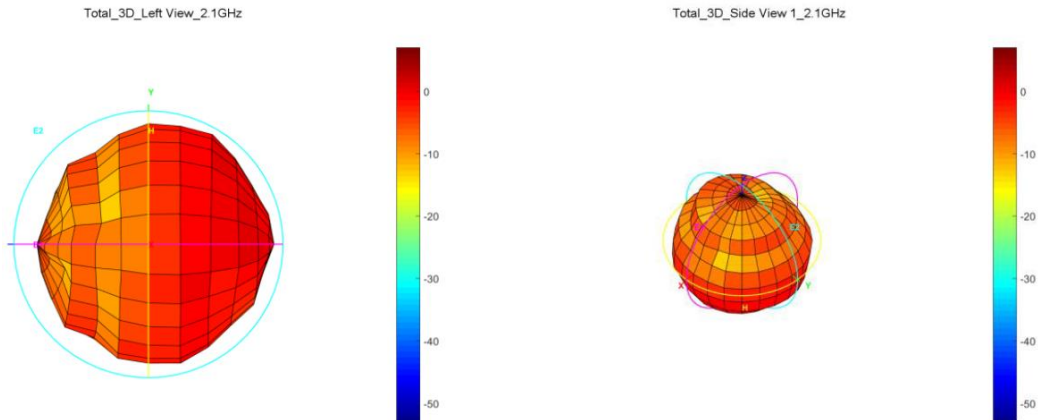

2D Radiation pattern

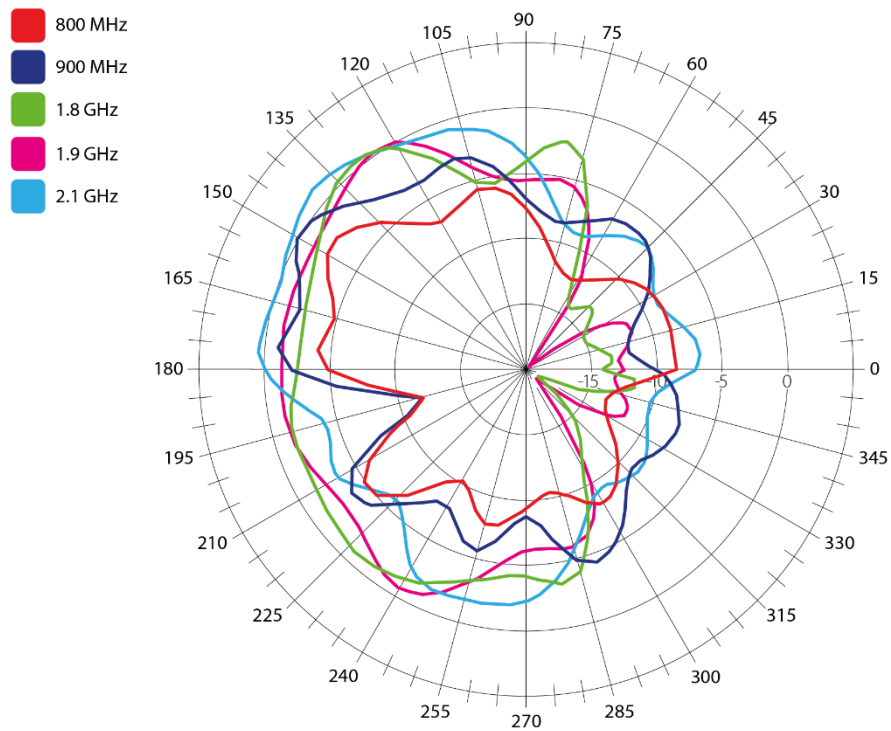

SUMMARY

Frequency (MHz)	VSWR	Efficiency (%)	Gain (dBi)
800	2.24	16.98	-2.41
900	1.50	29.99	0.27
1800	1.71	36.39	0.36
1900	1.46	33.81	0.12
2100	4	49.89	1.3

CONTACTS