



GSM ANTENNA

Antenna GSM Adhesive 25,
2.5 dBi, SMA(m), RG174U/1m

AO-AGSM-SA1S100

SECTRON company offers a wide portfolio of GSM antennas with various versions differing in shape, level of gain and manner of attachment. SECTRON guarantees a compatible connection between an antenna and all antenna adaptors produced by SECTRON.



BENEFITS

- Low VSWR
- Easy installation
- Omnidirectional - suitable for moving devices

Technology	GSM
Frequency bands	900/1800/1900/2100 MHz
Bandwidth	-
Gain	2.5 dBi
VSWR	<2.0:1
Impedance	50 Ohm
Directivity	Omnidirectional
Beam angle	H 360° V 30°
Polarization	Vertical
Maximum input power	10 W
Power voltage	-
Dimensions	129.5 x 22.8 x 6.7 mm
Weight	33.2 g
Operating temperature	-30 to +80 °C
Execution	External
Method of attachment	Adhesive
Cable type	RG174/U
The cable length	1 m
Connector type	SMA (m)

DRAWING

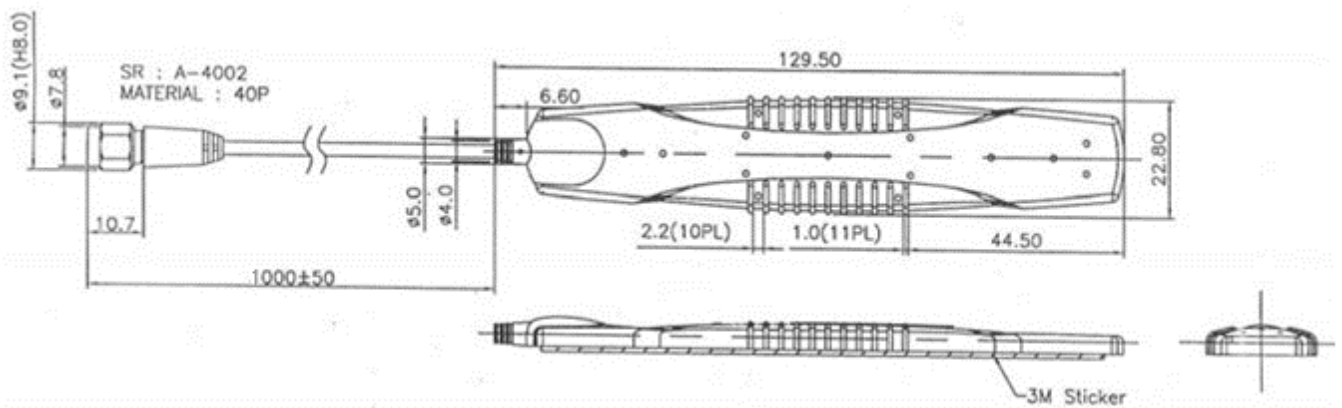

Far-field amplitude of AG-08.nsi

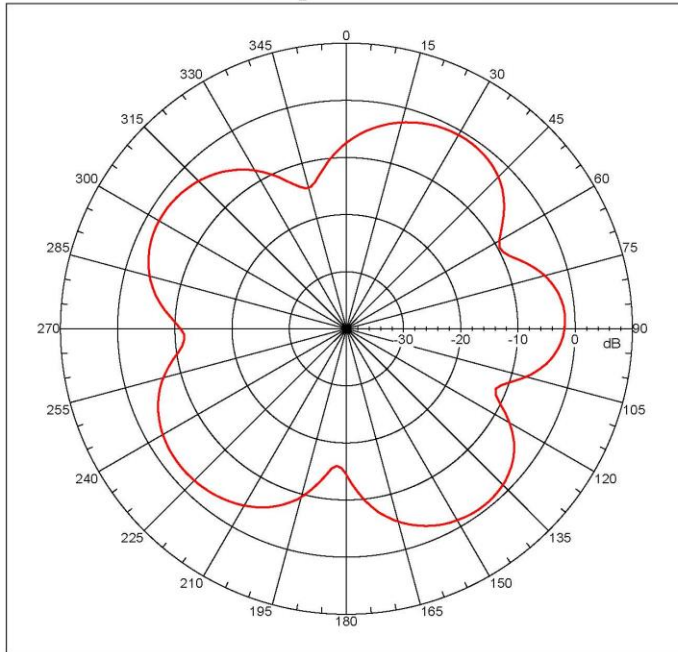

```

Far-field amplitude, Eprincipal: Linear, Tau = 0.000 deg
Gain = -5.78415 dBi
Max far-field (global) = -41.71016 dB, Max far-field (plot) =
-41.7102 dB
Normalization: Reference, Network offset = 0.000 dB
Rpeak at: 141.99999 deg, Vpeak at: 0.000 deg
Plot centering: On

AG-08E-Plane cut scan. Feeding cable at bottom side around RJC
been covered by absorber to reduce possible coupling with
AUT.

NSI2000 V4.0.124, Filename:C:\nsi2000\T.Y.HUB\RF-28A\AG-08.nsi
Measurement date/time: 5/17/2007 4:32:48 PM, Filetype: NSI-97
Far-field Cut Analysis:
Avg value: -4.046 dB
-3. dB beam width: 35.82 deg
-6. dB beam width: 48.72 deg
-15. dB beam width: 69.07 deg
Left Sidelobe: -0.96 dB at 87.486 deg
Right Sidelobe: Not Found
Far-field display setup
Azimuth (deg)
Span = 365.00001 deg, Center = 9.000 deg, #pts = 181
Start = -180.00001 deg, Stop = 180.00001 deg, Delta = 2.000
deg
Elevation (deg)
Center = 9.000 deg, #pts = 1

Selected beam(s) 1 of 6
Beam Frequency Azimuth Elevation Pol
----
1 0.890 GHz Azimuth Elevation Single-pol
    
```

Far-field amplitude of AG-08.nsi

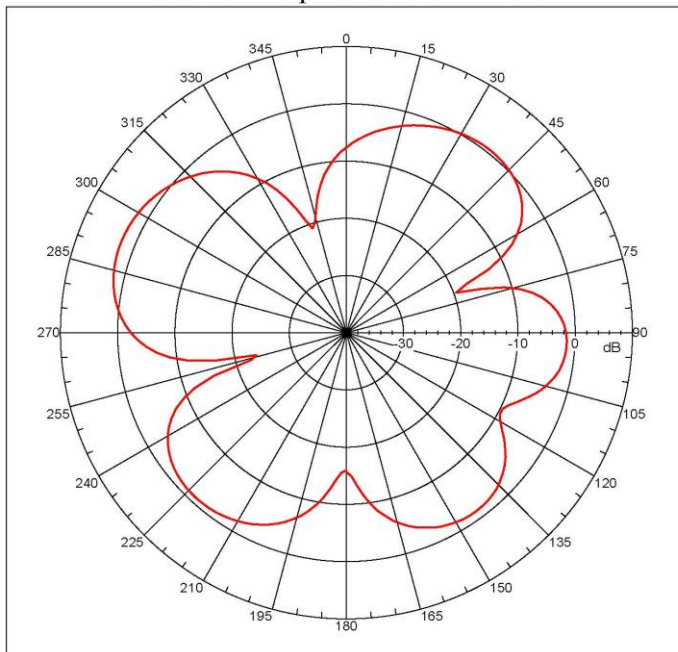

```

Far-field amplitude, Eprincipal: Linear, Tau = 0.000 deg
Gain = 2.42511 dBi
Max far-field (global) = -40.19457 dB, Max far-field (plot) =
-40.19457 dB
Normalization: Reference, Network offset = 0.000 dB
Rpeak at: -68.800 deg, Vpeak at: 8.000 deg
Plot centering: On

AG-08E-Plane cut scan. Feeding cable at bottom side around RJC
been covered by absorber to reduce possible coupling with
AUT.

NSI2000 V4.0.124, Filename:C:\nsi2000\T.Y.HUB\RF-28A\AG-08.nsi
Measurement date/time: 5/17/2007 4:32:48 PM, Filetype: NSI-97
Far-field Cut Analysis:
Avg value: -3.720 dB
-3. dB beam width: 38.56 deg
-6. dB beam width: 52.85 deg
-15. dB beam width: 65.24 deg
Left Sidelobe: -3.39 dB at -137.765 deg
Right Sidelobe: -1.84 dB at 39.218 deg
Far-field display setup
Azimuth (deg)
Span = 365.00001 deg, Center = 9.000 deg, #pts = 181
Start = -180.00001 deg, Stop = 180.00001 deg, Delta = 2.000
deg
Elevation (deg)
Center = 9.000 deg, #pts = 1

Selected beam(s) 1 of 6
Beam Frequency Azimuth Elevation Pol
----
1 0.950 GHz Azimuth Elevation Single-pol
    
```

Far-field amplitude of AG-08.nsi

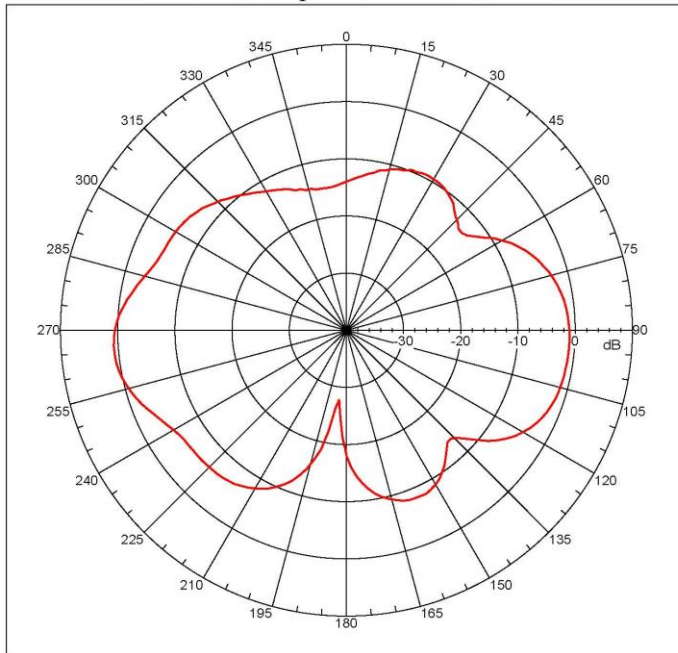

Far-field amplitude, Eprincipal: Linear, Tau = 0.000 deg
 Gain = 0.74775 dBi
 Max far-field (global) = -44.30258 dB, Max far-field (plot) = -44.30262 dB
 Normalization: Reference, Network offset = 0.000 dB
 Hpeak at: -94.00001 deg, Vpeak at: 0.000 deg
 Plot centering: On
 AG-08E-Plane cut scan. Feeding cable at bottom side around RJC been covered by absorber to reduce possible coupling with AUT.
 NSI2000 V4.0.124, Filename:C:\nsi2000\T.Y.HUS\PP-28A\AG-08.nsi
 Measurement date/time: 5/17/2007 4:32:48 PM, Filetype: NSI-97
 Far-field Cut Analysis:
 Avg Value: -4.658 dB
 -3. dB beam width: 31.71 deg
 -6. dB beam width: 55.67 deg
 -10. dB beam width: 113.56 deg
 Left Sidelobe: Not Found
 Right Sidelobe: -18.17 dB at 29.162 deg
 Far-field display setup
 Azimuth (deg)
 Span = 360.00001 deg, Center = 0.000 deg, #pts = 181
 Start = -180.00001 deg, Stop = 180.00001 deg, Delta = 2.000 deg
 Elevation (deg)
 Center = 0.000 deg, #pts = 1
 Selected beam(s) 1 of 6
 Beam Frequency Azimuth Elevation Pol

 4 1.710 GHz Azimuth Elevation Single-pol

Far-field amplitude of AG-08.nsi

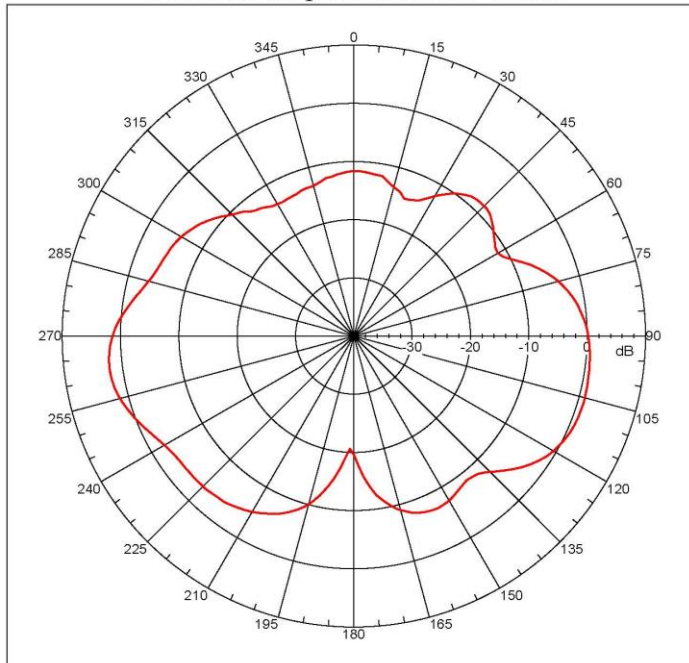

Far-field amplitude, Eprincipal: Linear, Tau = 0.000 deg
 Gain = 0.22258 dBi
 Max far-field (global) = -44.30981 dB, Max far-field (plot) = -44.30983 dB
 Normalization: Reference, Network offset = 0.000 dB
 Hpeak at: -98.00001 deg, Vpeak at: 0.000 deg
 Plot centering: On
 AG-08E-Plane cut scan. Feeding cable at bottom side around RJC been covered by absorber to reduce possible coupling with AUT.
 NSI2000 V4.0.124, Filename:C:\nsi2000\T.Y.HUS\PP-28A\AG-08.nsi
 Measurement date/time: 5/17/2007 4:32:48 PM, Filetype: NSI-97
 Far-field Cut Analysis:
 Avg value: -5.331 dB
 -3. dB beam width: 30.47 deg
 -6. dB beam width: 65.36 deg
 -10. dB beam width: 107.67 deg
 Left Sidelobe: Not Found
 Right Sidelobe: -13.91 dB at 3.017 deg
 Far-field display setup
 Azimuth (deg)
 Span = 360.00001 deg, Center = 0.000 deg, #pts = 181
 Start = -180.00001 deg, Stop = 180.00001 deg, Delta = 2.000 deg
 Elevation (deg)
 Center = 0.000 deg, #pts = 1
 Selected beam(s) 1 of 6
 Beam Frequency Azimuth Elevation Pol

 5 1.800 GHz Azimuth Elevation Single-pol

VARIANT	PART NUMBER
Antenna GSM Adhesive 25/open, 2.5dBi, RG174/3m	AO-AGSM-SA1
Antenna GSM Adhesive 25, 2.5dBi, MMCX(m)R/A, RG174 2m	AO-AGSM-SA1C
Antenna GSM Adhesive 25, 2.5dBi, FME(f), RG174/3m	AO-AGSM-SA1F
Antenna GSM Adhesive 25, 2.5dBi, MCX(m)R/A, RG174/40cm	AO-AGSM-SA1M
Antenna GSM Adhesive 25, 2.5dBi, SMA(m), RG174U/3m	AO-AGSM-SA1S