



GSM ANTENNA

Antenna GSM Screw Mount
R36, SMA(m), RG174/3m, IP67

AO-AGSM-36S

SECTRON company offers wide portfolio of GSM antennas with various versions differing in shape, level of gain or attachment manner. SECTRON guarantees a compatible connection between antenna and all antenna adaptors produced by SECTRON.



BENEFITS

- Low VSWR
- Omnidirectional – suitable for moving devices
- Anti-vandal design

Technology	GSM/UMTS
Frequency bands	800/900/1700/1800/1900/2100 MHz
Bandwidth	-
Gain	2 dBi
VSWR	<2.0:1
Impedance	50 Ohm
Directivity	Omnidirectional
Beam angle	H 360° V 30°
Polarization	Linear
Maximum input power	10 W
Power voltage	-
Dimensions	Ø 54.4 x 42.9 mm
Weight	80.09 g
Operating temperature	-30 to +90 °C
Execution	External
Method of attachment	Screw Mount
Cable type	RG174 / U
The cable length	3 m
Connector type	SMA(m)

DRAWING

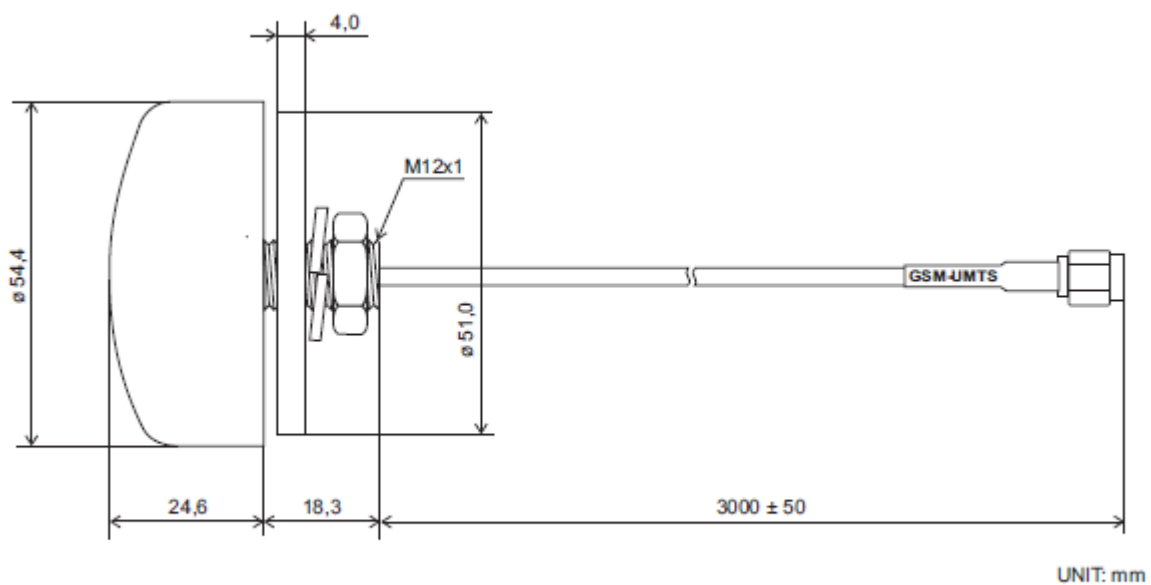

Far-field amplitude 900 MHz-E.nsi

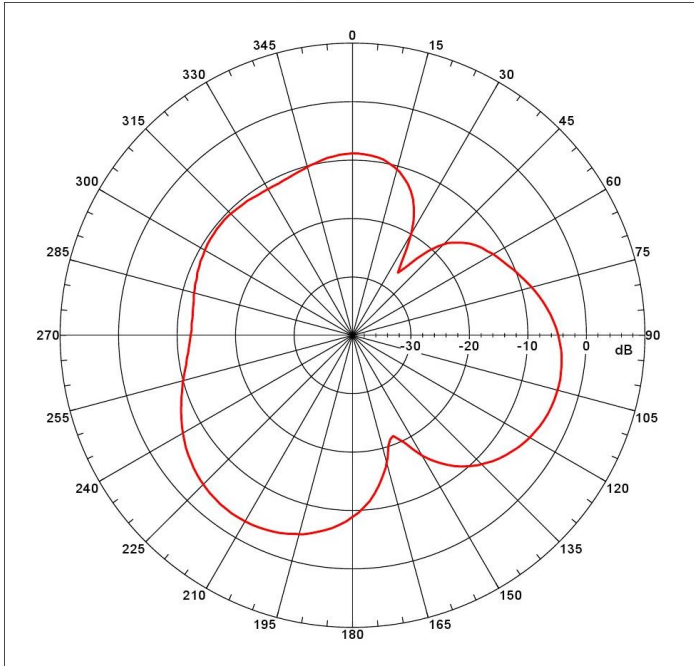

Far-field amplitude 900 MHz-H.nsi

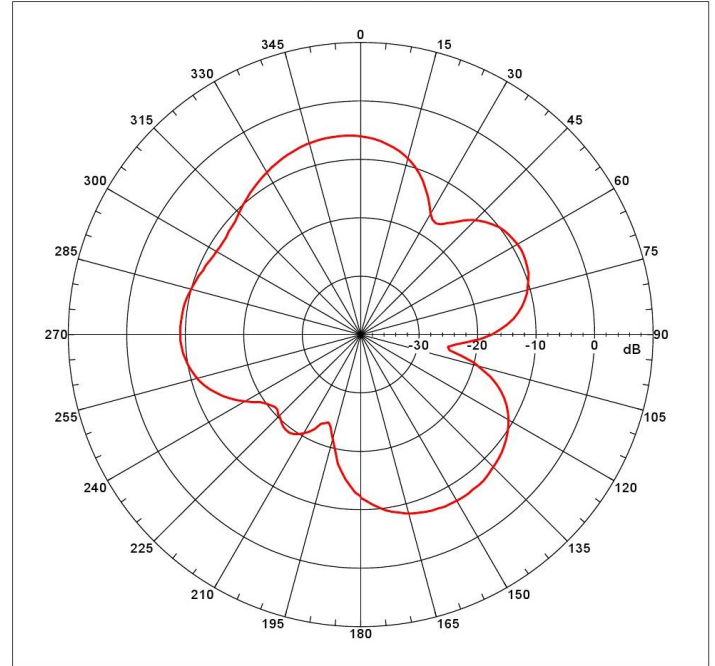

Far-field amplitude 1 800 MHz -E.nsi

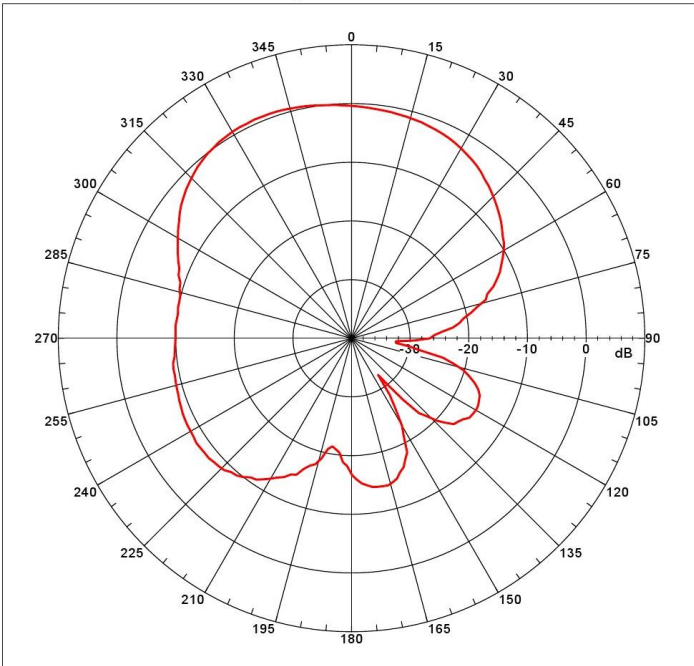

Far-field amplitude 1 800 MHz -H.nsi

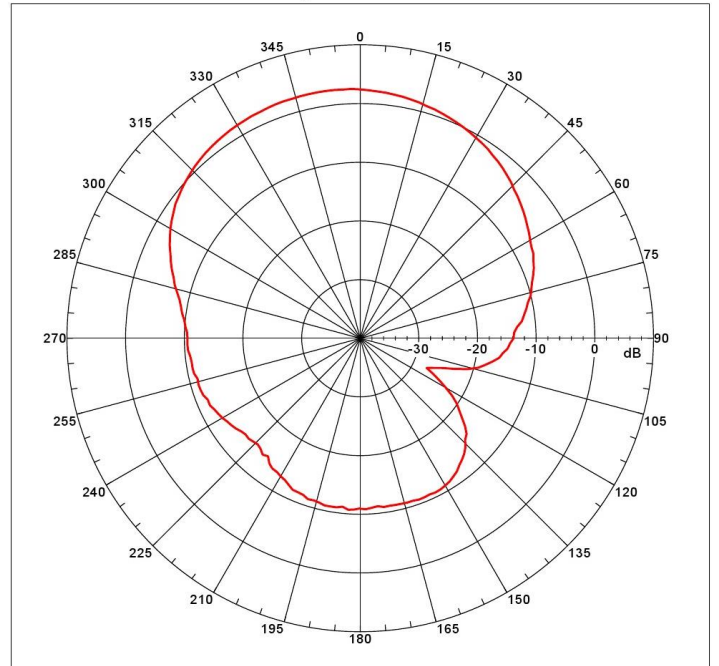

Far-field amplitude 1 900 MHz -E.nsi

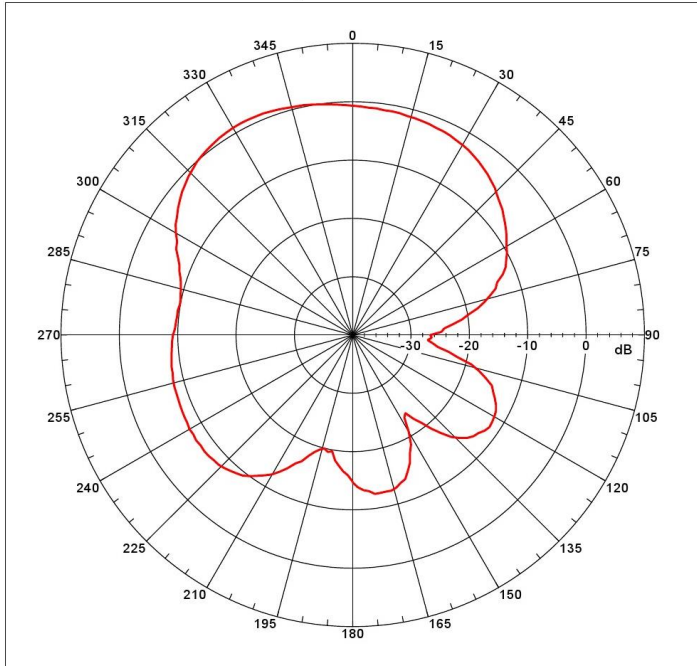

Far-field amplitude 1 900 MHz -H.nsi

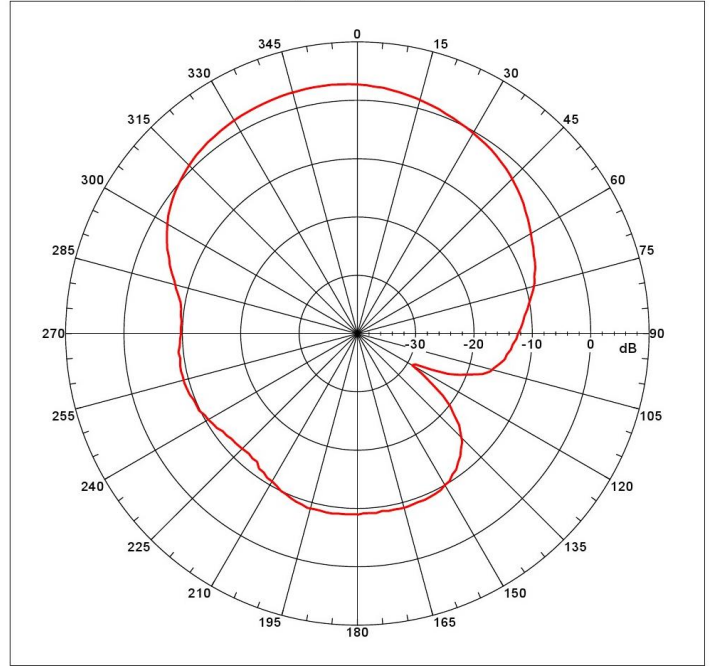

Far-field amplitude 2 100 MHz -E.nsi

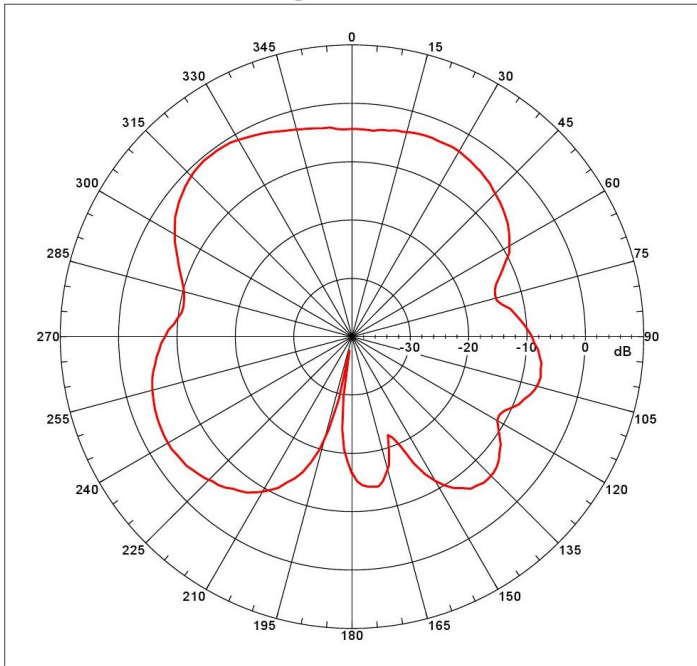

Far-field amplitude 2 100 MHz -H.nsi

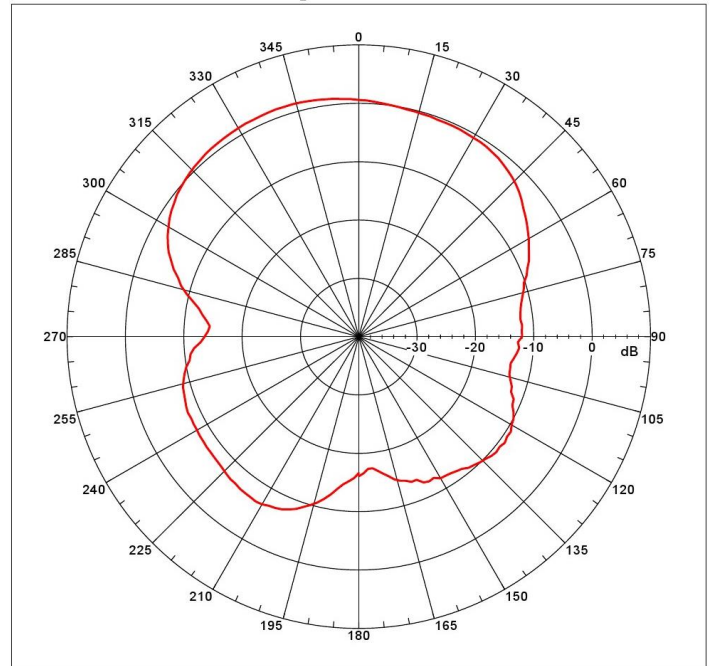

VSWR

VSWR

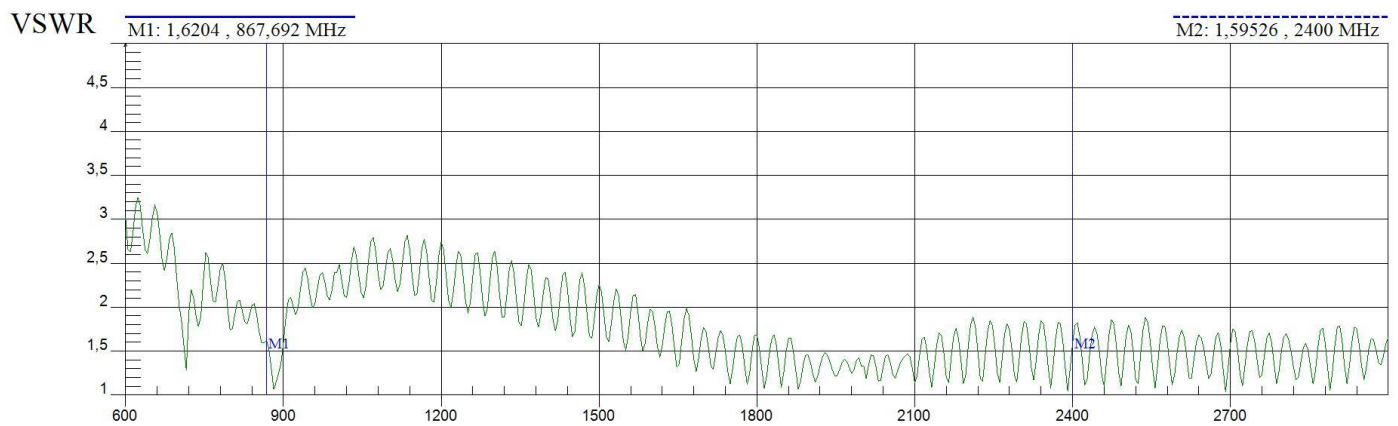

Date: 2021/05/20
Time:

Frequency(600 - 3000 MHz)
Resolution: 521
Cal: ON

IIM: OFF
Keysight
SN: CN0132000230

ALL VARIANTS

O-AGSM-36S

Different connector variants or cable lengths are available on request.

CONTACTS

SECTRON s.r.o. Josefa Šavla 1271/12
709 00 Ostrava 9, Czech Republic

WWW.SECTRON.CZ
Tel.: +420 556 621 020