



## GSM ANTENNA

Antenna GSM Mount R36,  
PUK, RG174/3m, FME(f)

AO-AGSM-36F

SECTRON company offers a wide portfolio of GSM antennas with various versions differing in shape, level of gain and manner of attachment. SECTRON guarantees a compatible connection between an antenna and all antenna adaptors produced by SECTRON.



### BENEFITS

- Low VSWR
- Omnidirectional – suitable for moving devices
- Anti-vandal design

Technology	GSM
Frequency bands	800/900/1700/1800/1900/2100 MHz
Bandwidth	-
Gain	0 dBi
VSWR	<2.0:1
Impedance	50 Ohm
Directivity	Omnidirectional
Beam angle	H 360° V 30°
Polarization	Linear
Maximum input power	10 W
Power voltage	-
Dimensions	Ø 54.4 x 28.6 mm
Weight	107.9 g
Operating temperature	-30 to +90 °C
Execution	External
Method of attachment	Mounting
Cable type	RG174 / U
The cable length	3 m
Connector type	FME(f)

DRAWING

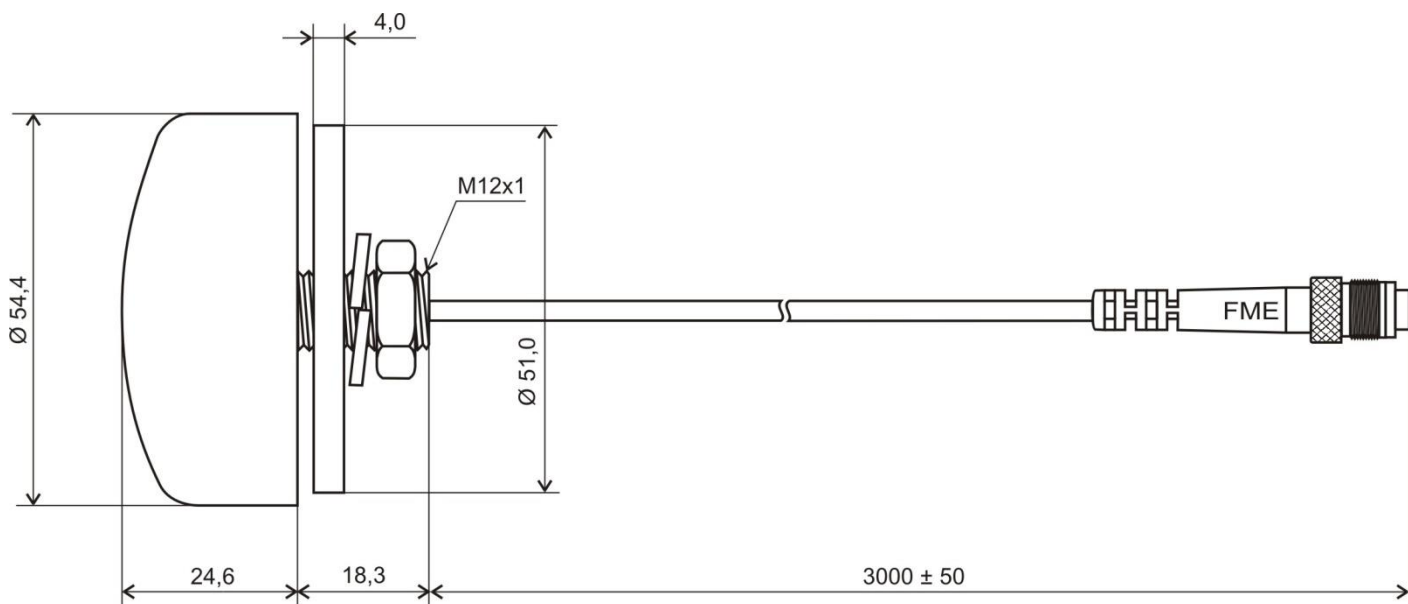

UNIT: mm

Far-field amplitude 900 MHz-E.nsi

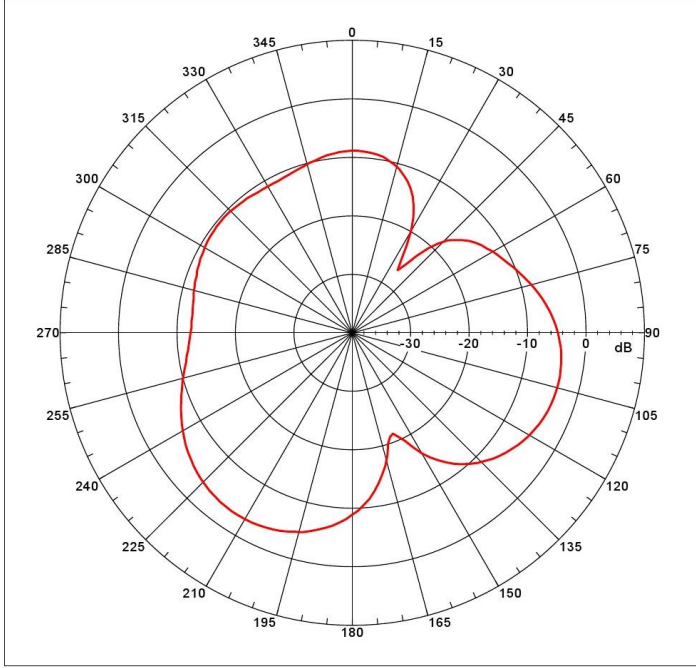

Far-field amplitude 900 MHz-H.nsi

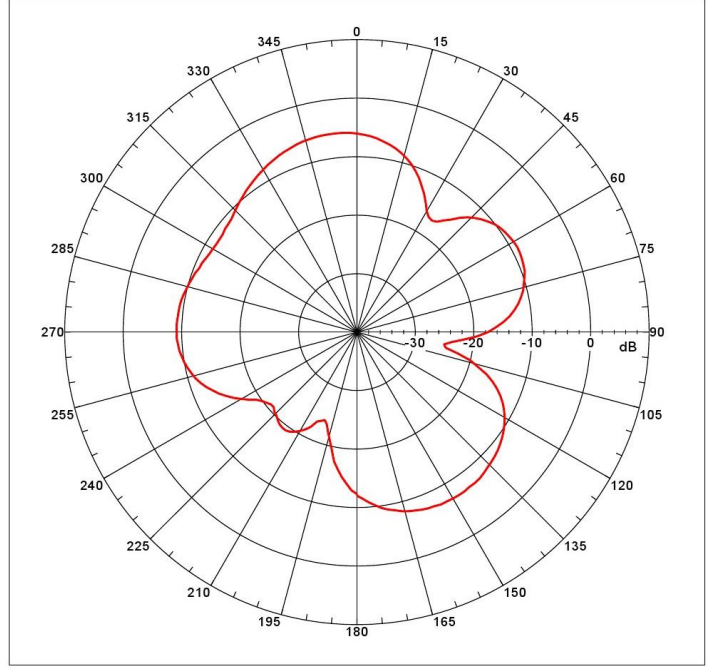

Far-field amplitude 1 800 MHz -E.nsi

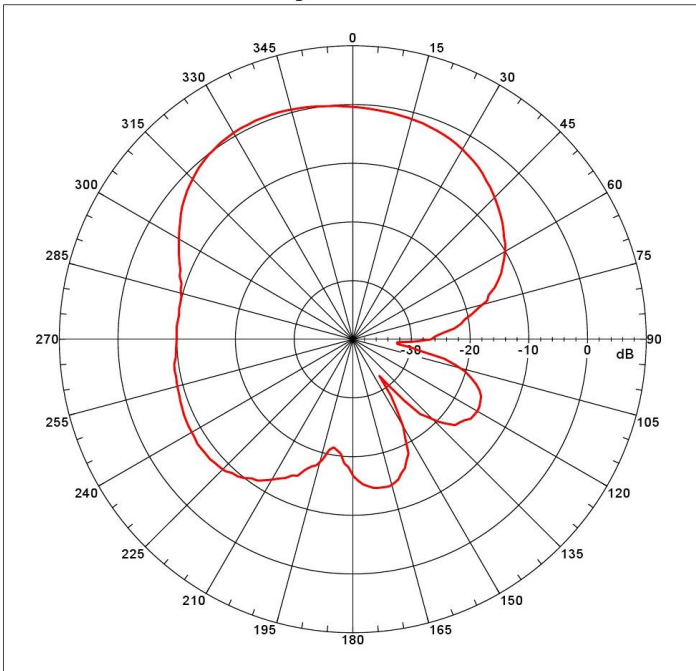

Far-field amplitude 1 800 MHz -H.nsi

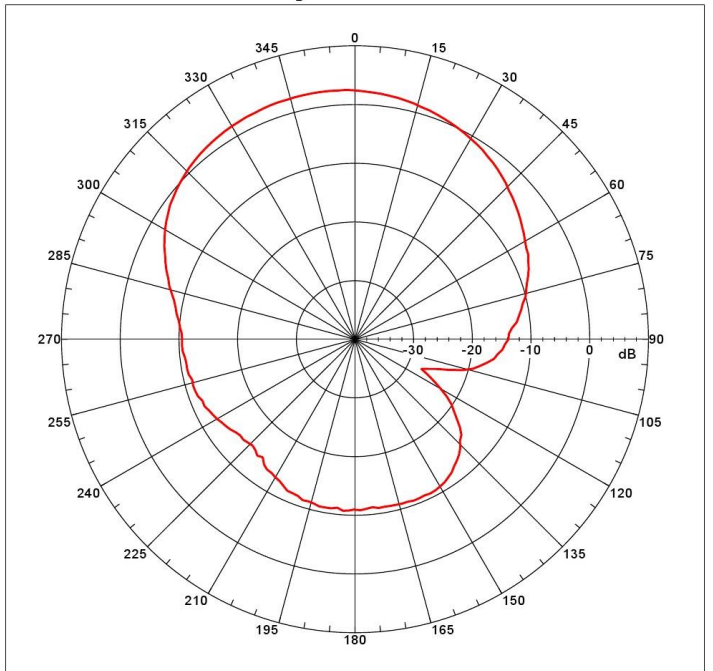

Far-field amplitude 1 900 MHz -E.nsi

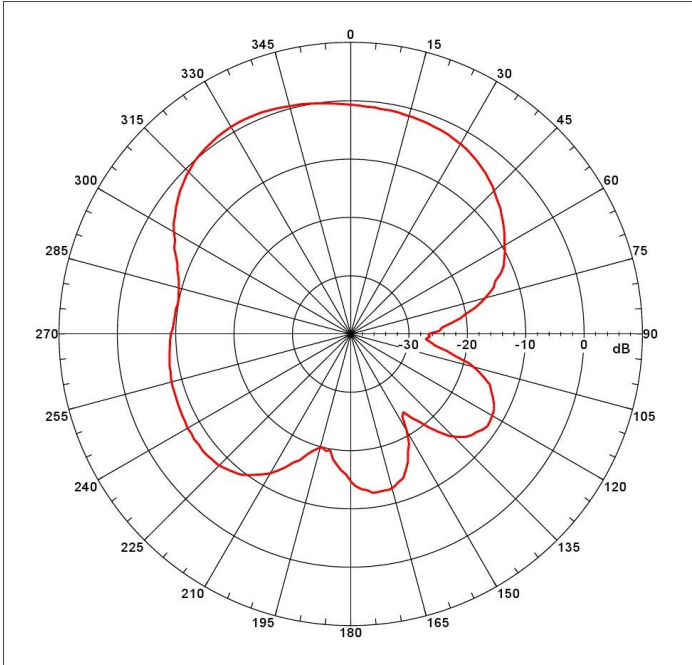

Far-field amplitude 1 900 MHz -H.nsi

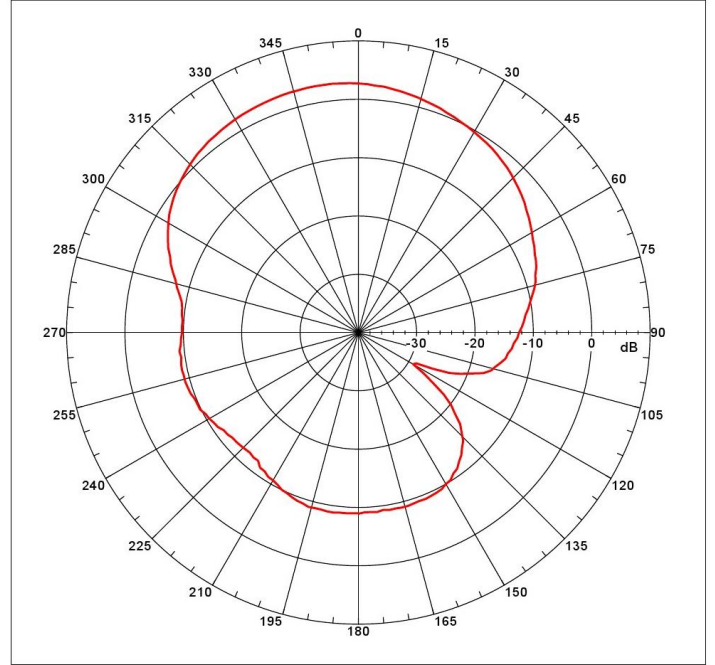

Far-field amplitude 2 100 MHz -E.nsi

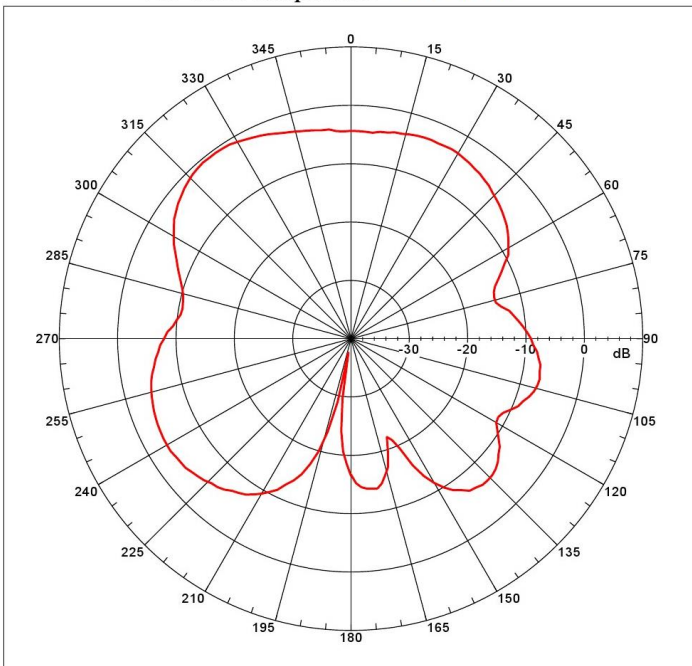

Far-field amplitude 2 100 MHz -H.nsi

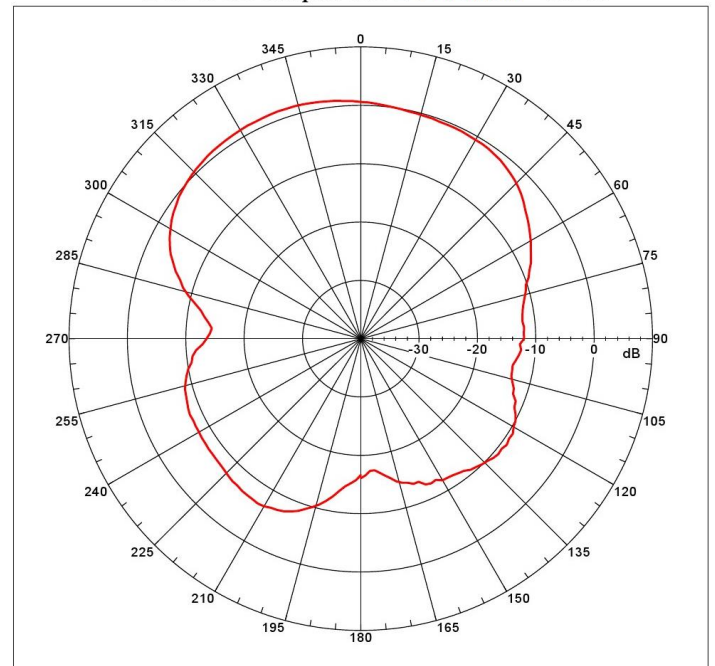

Different connector variants or cable lengths are available on request.

CONTACTS

---

SECTRON s.r.o. Josefa Šavla 1271/12  
709 00 Ostrava 9, Czech Republic

WWW.SECTRON.CZ  
Tel.: +420 556 621 021