



ISM ANTENNA

Antenna 433 MHz 824, 3m RG174,
open end, soldered

AO-A433-D824-03

SECTRON company offers a wide portfolio of ISM antennas with various versions differing in shape, level of gain and manner of attachment. SECTRON guarantees a compatible connection between an antenna and all antenna adaptors produced by SECTRON.



BENEFITS

- Easy installation
- Low VSWR

FEATURES

AO-A433-D824-03

Technology	ISM
Frequency bands	433 MHz
Bandwidth	10 MHz
Gain	0 dBi
VSWR	<2.0:1
Impedance	50 Ohm
Directivity	Omnidirectional
Beam angle	H 100° V 60°
Polarization	Linear
Maximum input power	10 W
Power voltage	-
Dimensions	150.2 x 21.5 x 8.7 mm
Weight	42.27 g
Operating temperature	-40 to +85 °C
Execution	External
Method of attachment	Adhesive
Cable type	RG174/U
The cable length	3 m
Connector type	Open end
Certification	ROHS

DRAWING

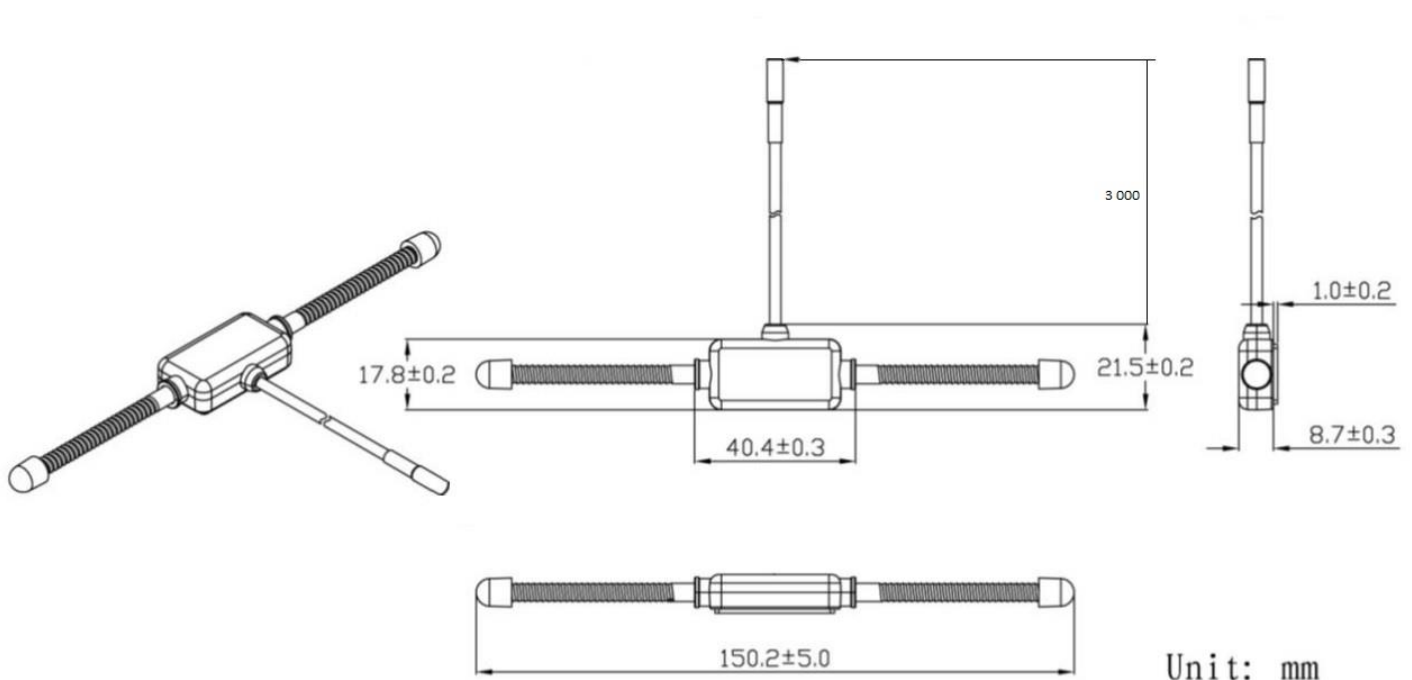

VSWR



RADIATION PATTERN

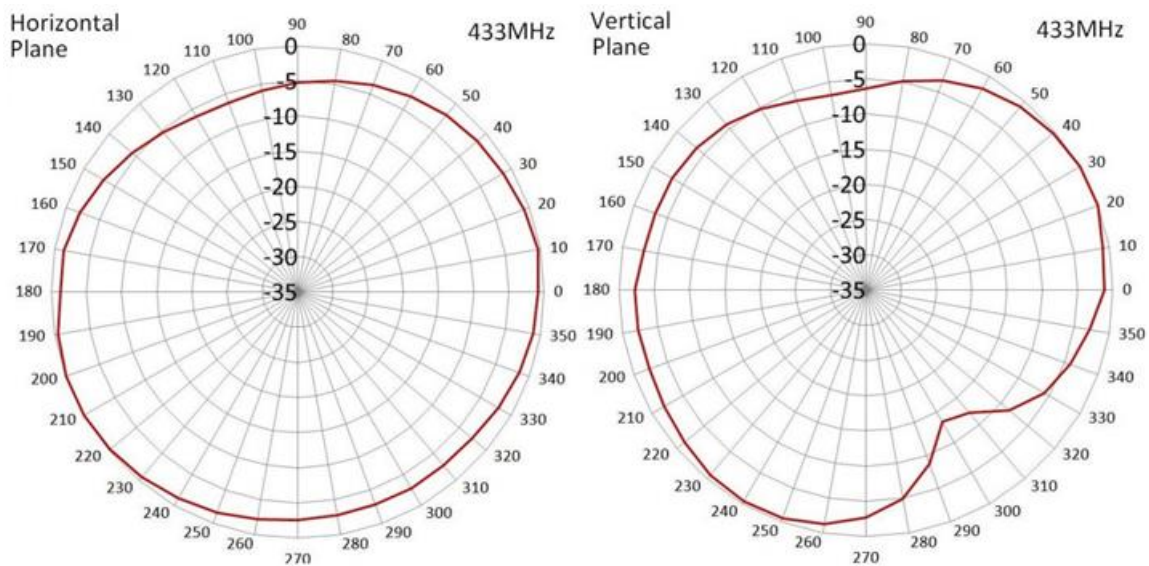

VARIANTS

Different connector variants or cable lengths are available on request.

CONTACTS

SECTRON s.r.o. Josefa Šavla 1271/12
709 00 Ostrava 9, Czech Republic

WWW.SECTRON.CZ
Tel.: +420 556 621 020