



GPS/LTE ANTENNA

Antenna LTE/GPS Screw Mount B062,
2 x SMA(m), 2 x RG174/3m

AO-AKOM-B062SS

SECTRON company offers a wide portfolio of LTE antennas with various versions differing in shape, level of gain and manner of attachment. SECTRON guarantees a compatible connection between an antenna and all antenna adaptors produced by SECTRON.



BENEFITS

- Low VSWR
- High power supply range

Technology	GPS/LTE
Frequency bands	1575.4/700-960/1710-2655 MHz
Bandwidth	± 5 MHz
Gain	3/2 dBi
LNA gain	28 dB
VSWR	<1.5:1 / <2.0:1
Impedance	50 Ohm
Directivity	Omnidirectional/Directional
Beam angle	H 360° V 30°
Polarization	Linear/R.H.C.P.
Maximum input power	10 W
Power voltage	2.2 – 5 V DC
Dimensions	Ø50 x 48 mm
Weight	144.6 g
Operating temperature	-45 to +85 °C
Execution	External
Method of attachment	Screw mount
Cable type	2 x RG174
The cable length	2 x 3 m
Connector type	2 x SMA(m)

DRAWING

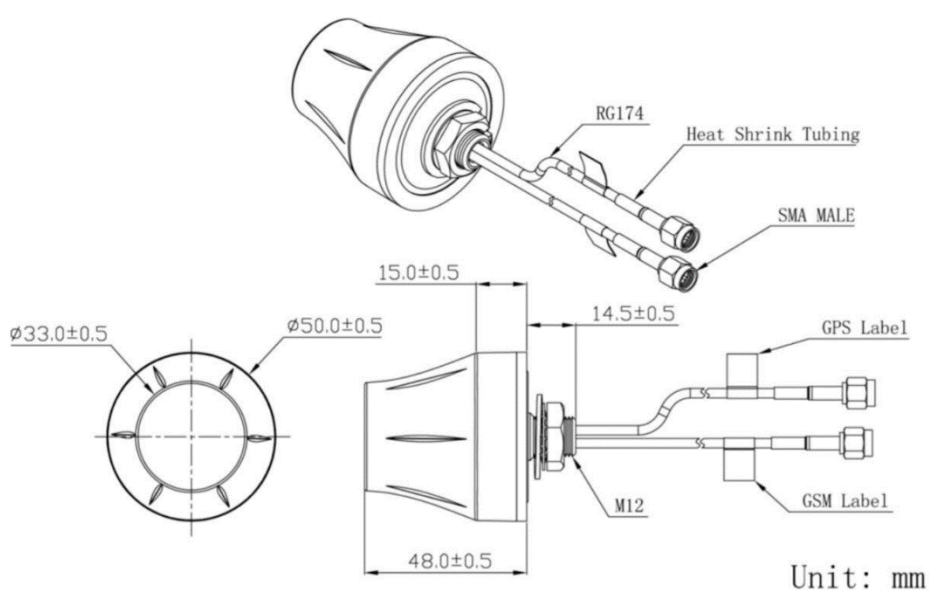

GPS LNA/ FILTER PARAMETERS

LNA Gain	28±2 dB
Noise Figure	1.5 dB
Filter Out Band Attenuation	12 dB Min / $f_0+50\text{MHz}$ 16 dB Min / $f_0-50\text{MHz}$
DC Voltage	2.2~5 V
DC Current	5~15 mA

SIMULATED GRAFS

GPS Antenna

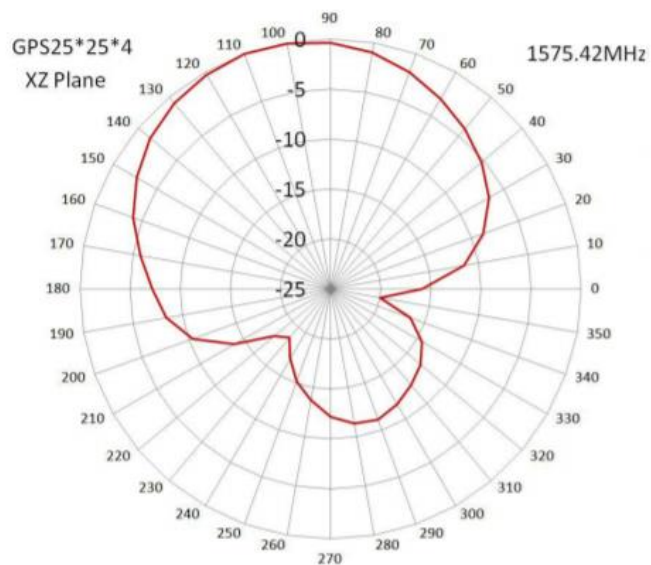
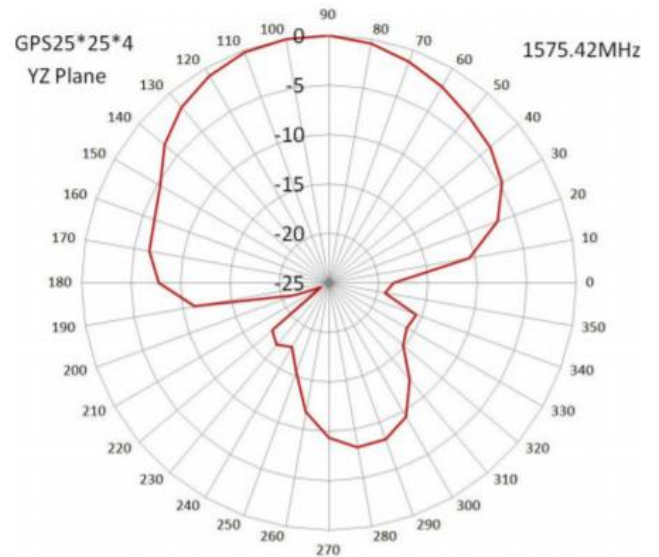
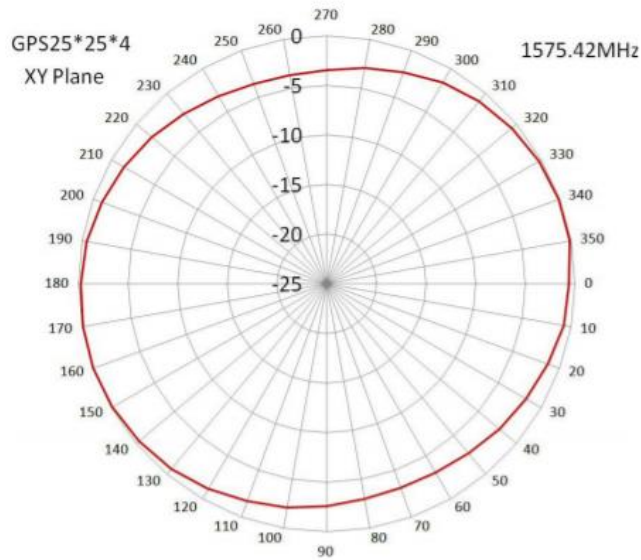

GSM Antenna

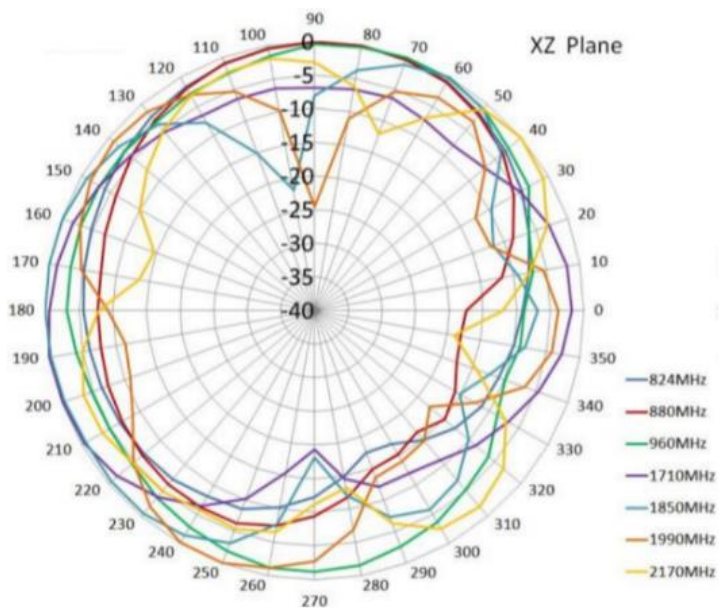
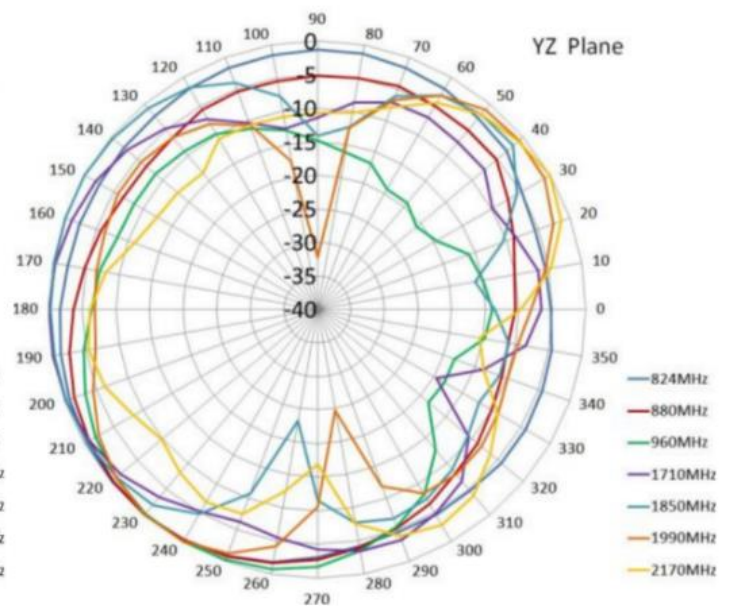
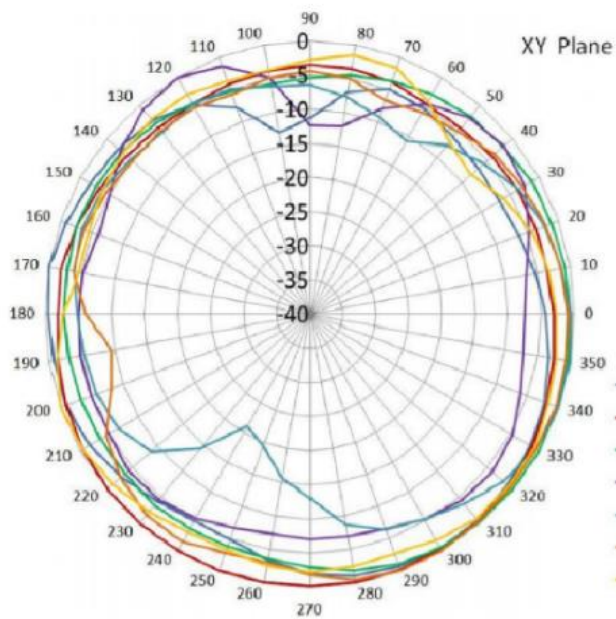

CONTACTS

SECTRON s.r.o. Josefa Šavla 1271/12
709 00 Ostrava 9, Czech Republic

WWW.SECTRON.CZ
Tel.: +420 556 621 020